

State of Iowa Public Drinking Water Program 2010 Annual Compliance Report



Environmental Services Division
Water Quality Bureau
Water Supply Engineering & Operations Sections

June 2011

Iowa Department of Natural Resources
Roger L. Lande, Director



Table of Contents

Title Page: Photo of New Infrastructure Built in 2010	i
Introduction	1
2010 Report Highlights	1
Compliance with Health-Based Standards	1
Map of Iowa's PWS with Health-Based Standards Violations in 2010	2
Compliance with Monitoring & Reporting Requirements	3
Map of Iowa's PWS with Major Monitoring & Reporting Violations in 2010	4
The National Public Drinking Water Program: An Overview	5
The IDNR Drinking Water Program Components	6
On-site Inspection, Operation Permitting, Construction Permitting, Water Allocation and Use	
Permitting, Operator Certification, and Environmental Laboratory Certification	6
DWSRF Program, Capacity Development, Source Water Protection, PWS Security, and	
Technical Assistance Contracts	7
Iowa's Public Water Supply Systems	8
Definition of a PWS	9
Number of Iowa Systems	10
Map of Iowa's Active Public Water Supplies in 2010	10
System Size	10
System Source Water	11
Population Served by Source Water Type	11
Maximum Contaminant Levels and Maximum Residual Disinfectant Levels	12
Acute Contaminants	12
Coliform Bacteria, including fecal and <i>E. coli</i>	12
Nitrate & Nitrite	13
Chlorine Dioxide	13
Chronic (non-acute) Contaminants	13
Total Coliform Bacteria	13
Inorganic Chemicals	14
Organic Chemicals	14
Radionuclides	15
Disinfectants	15
Action Level and Treatment Technique Requirements	16
Lead & Copper Action Levels	16
Treatment Techniques: Surface Water Treatment Rule, Interim & LT1 Enhanced SWTR	17
Turbidity	17
Residual Disinfectant (minimum)	17
CT Ratio	18
Disinfection Byproduct Precursor Removal	18
Groundwater Rule	18
Violation Data for Health-Based Standards: MCL, MRDL, AL, and TT	20
Major Monitoring & Reporting Violations	23
Major Monitoring & Reporting Violation Data	24
Monitoring & Reporting Compliance Rates	25
Enforcement Actions	26
Variations & Exemptions	27

Public Notification, Lead Public Education, and Consumer Confidence Reporting	27
Operator Certification	29
Classification of Systems, Facilities, and Operators	29
Classification Grades	30
Enforcement & Certification Renewal	31
Abbreviations	32
Distribution of Report & Staff Contact Information	33
Appendix A: EPA Violations Summary Report	A-1
Appendix B: Iowa Public Water Supply Violation Data	B-1

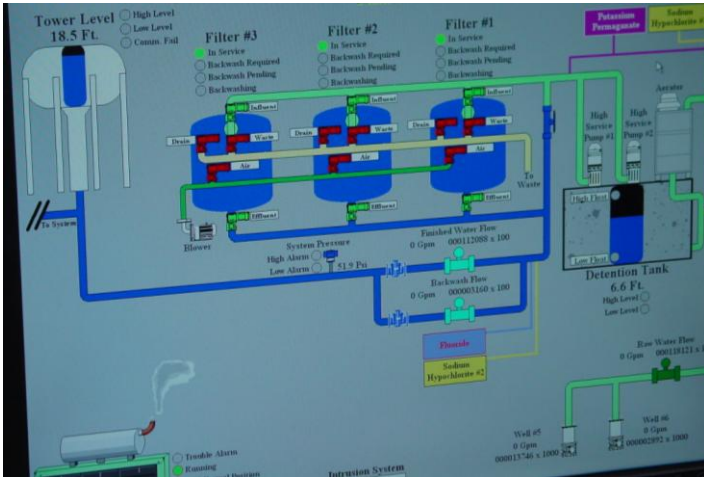

System's computer control interface



Liquid chlorine feed



Emergency power generator

Photos from Iowa's DWSRF Projects in 2010



Vertical turbine well pump with flow meter



Filter control panel

Introduction

The Iowa Department of Natural Resources (IDNR) administers the Public Drinking Water Program in Iowa under delegation of authority from the United States Environmental Protection Agency (EPA). The 1996 re-authorized Safe Drinking Water Act (SDWA) requires that each state that has been granted primary implementation authority prepare an annual report on violations of national primary drinking water regulations within the state, make the report readily available to the public, and submit it to the EPA. This report fulfills this responsibility in Iowa for the 2010 calendar year, and includes violations of maximum contaminant levels, maximum residual disinfectant levels, treatment technique requirements, action level exceedances, major monitoring or reporting requirements, and operation certification requirements.

The 2010 Report Highlights

The overall drinking water program compliance figures in 2010 continue to be very similar to those in the previous two years. There are three new federal rules that were in various stages of implementation in 2010 that also required effort to ensure compliance by Iowa's systems with these new requirements: Stage 2 Disinfectants/Disinfection Byproducts Rule, Long-term 2 Enhanced Surface Water Treatment Rule, and the Groundwater Rule. This was the first full year of implementing the Groundwater Rule, with the potential for a significant rise in violations that can occur whenever a new rule affecting many systems becomes effective. However, due to the diligence and communication efforts amongst the DNR Water Supply Program staff, system operators, and analytical laboratories, there not only was no increase but there was an actual decrease in the overall number of monitoring and reporting violations.

Compliance with Health-Based Standards

- No waterborne diseases or deaths were reported from Iowa public water supply systems (PWS) in 2010.
- Over 2.62 million people (of the 2.84M people served by PWS) regularly received water from systems meeting all health-based drinking water standards.
- Health-based drinking water standards were met by 91.0% of the 1,966 regulated public water supplies. There were 176 public water supplies that had 351 violations of a health-based drinking water standard: maximum contaminant level (MCL), maximum residual disinfectant level (MRDL), treatment technique (TT), or action level (AL).
- Eighteen of the more than 80 regulated contaminants were found at levels that exceeded the health-based standards during 2010. The top 12 contaminants are shown in the chart on the following page, along with the percentage each contributed to the total number of health-based standard violations. Six other health-based standards were each exceeded at least once during the year: the maximum contaminant levels for chlorite and uranium; and treatment techniques for nitrate, contact time, gross alpha, and significant deficiencies not promptly corrected.

Population served by Iowa systems meeting health-based standards
92%

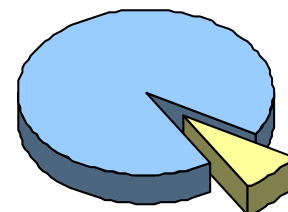

Population served by Iowa systems with health-based standard violations
8%

Iowa systems with health-based standard violations
9%

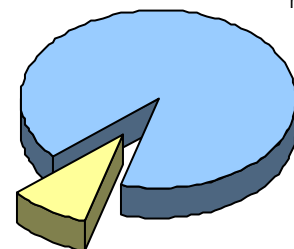

Iowa systems meeting health-based standards
91%

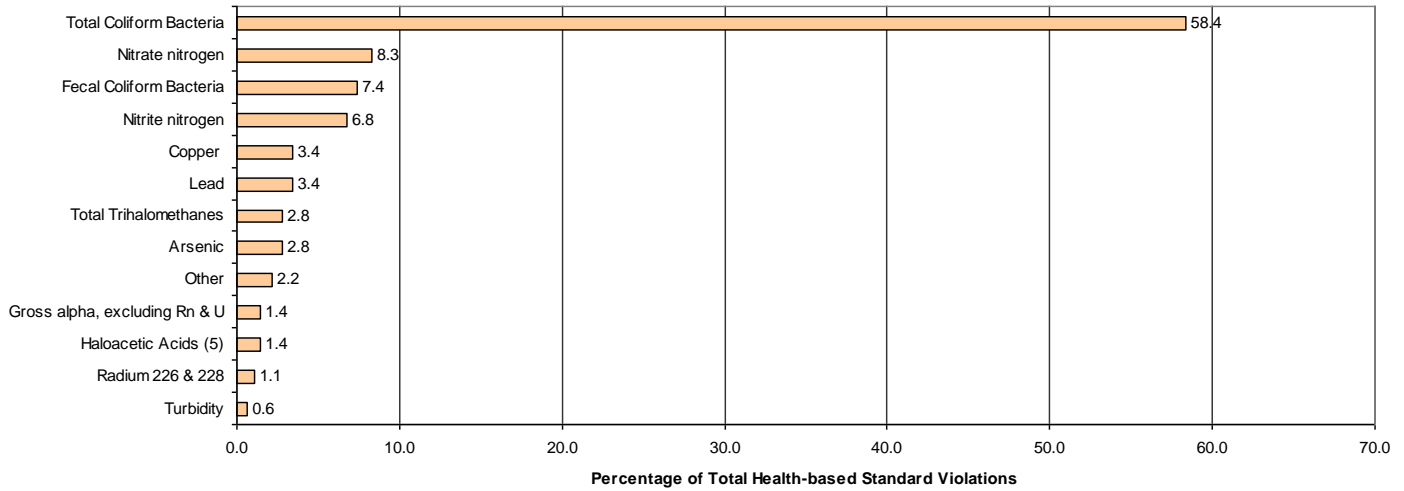

2010 Health-based Standard Violations Map

The map depicts the health-based standard violations that occurred in 2010 at Iowa's PWS. The three most common violations, non-acute total coliform bacteria, nitrate, and acute fecal coliform or *E. coli* bacteria, are denoted separately. The remaining violations are grouped together as "other".

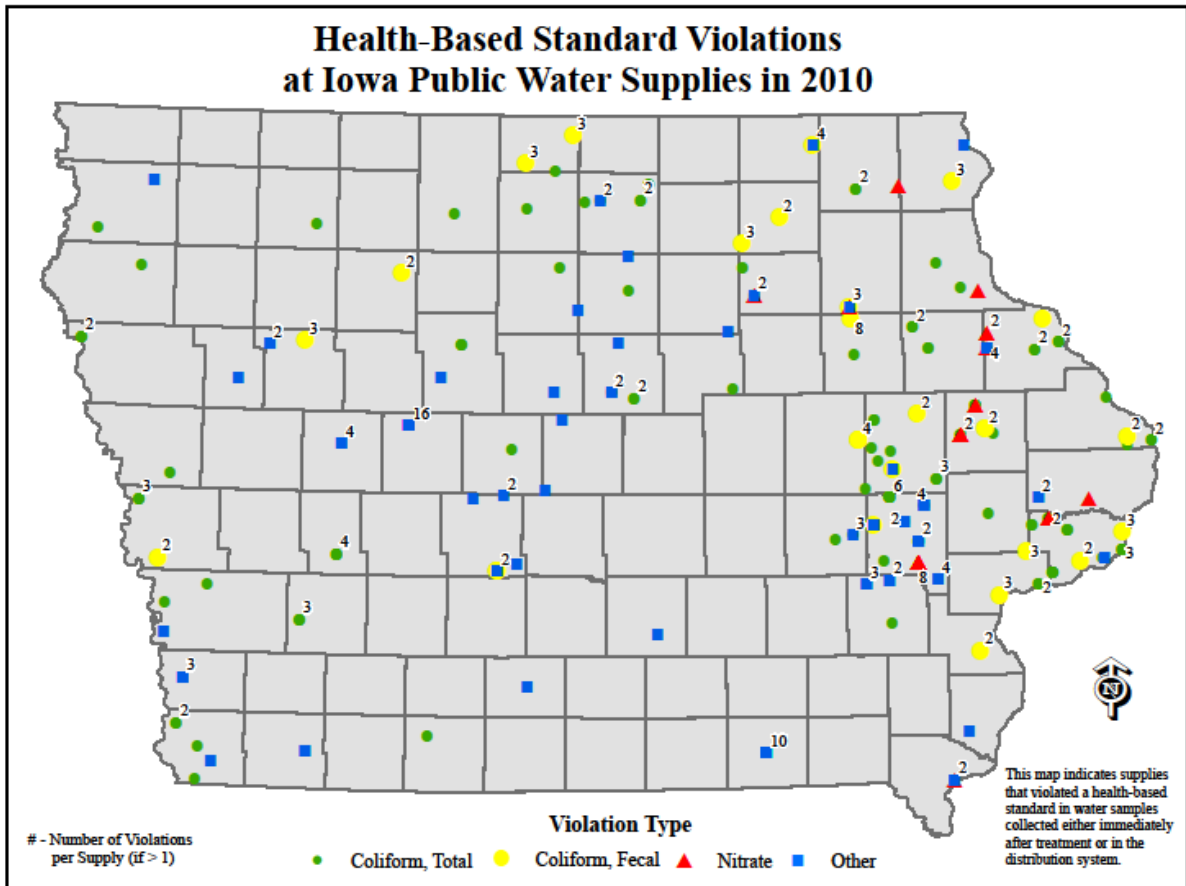

Compliance with Monitoring & Reporting Requirements

A major monitoring violation is incurred when a required sample is not collected for a specific contaminant.

- Over 2.56 million people regularly received water from Iowa systems that complied with all major monitoring and reporting requirements.

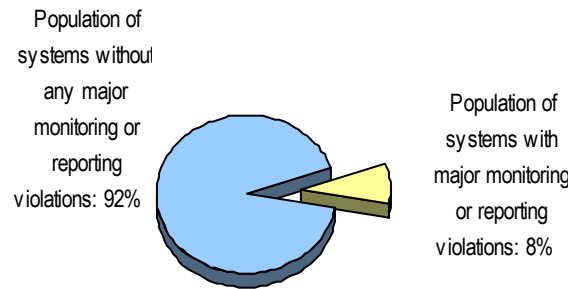

Systems in compliance with all major monitoring and reporting requirements
82%

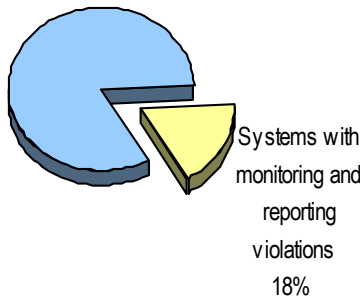

- Major monitoring and reporting requirements were met by 81.6% of the 1,966 regulated public water supply systems.
- There were 669 major monitoring violations in 2010 at 312 systems. The contaminants for which at least one major monitoring violation was issued are listed below, along with the percentage each contributed to the total number of monitoring violations.

- | | |
|---|--|
| <ul style="list-style-type: none"> ▪ Coliform bacteria: 55.3% ▪ Nitrate: 19.3% ▪ Coliform bacteria (GWR Source): 8.2% ▪ Chlorine: 4.2% ▪ Lead: 1.9% ▪ Copper: 1.8% ▪ Haloacetic Acids: 1.8% ▪ Total Trihalomethanes: 1.8% | <ul style="list-style-type: none"> ▪ Nitrite: 1.4% ▪ Metals: 1.2% ▪ Gross Alpha: 0.9% ▪ Radium 226 & 228: 0.9% ▪ Volatile Organic Compounds: 0.6% ▪ Synthetic Organic Compounds: 0.4% ▪ Uranium: 0.3% |
|---|--|

At least one reporting violation was incurred by 72 systems, for a total of 88 reporting violations. These violations were comprised of the following (both the actual number of violations and the percentage of total reporting violations are listed):

- Failure to submit the required monthly operation report: 19 (21.6%)
- Failure to conduct public notification: 8 (9.1%)
- Failure to provide a consumer confidence report: 19 (21.6%)
- Failure to obtain a certified operator: 19 (21.6%)
- Failure to meet a compliance schedule: 16 (18.2%)
- Failure to obtain a construction permit: 6 (6.8%)
- Failure to have a monitoring plan: 1 (1.1%)

The 16 categories of monitoring and reporting violations are shown in the following chart, along with the number each contributed to the total number of monitoring and reporting violations.

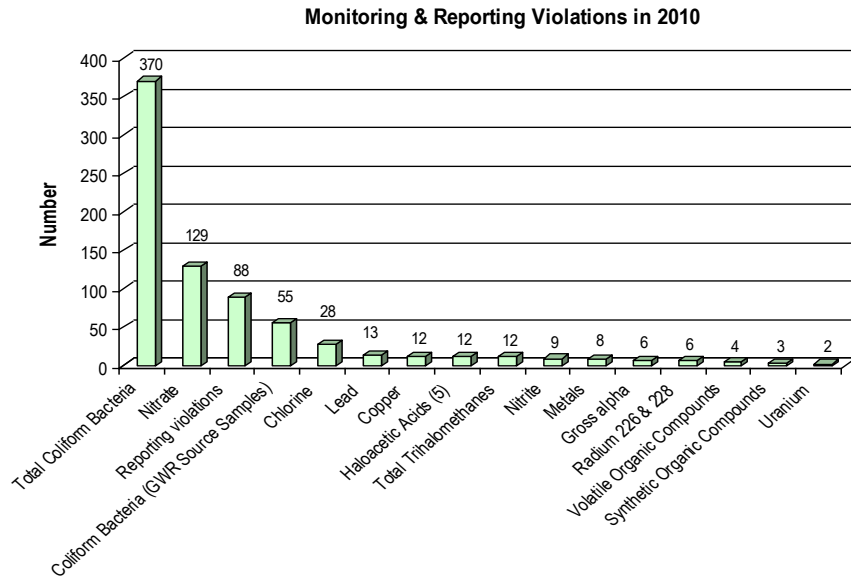

2010 Major Monitoring & Reporting Violations Map

This map depicts the systems in Iowa that incurred a major monitoring or reporting violation in 2010. The system with the most violations incurred 23.

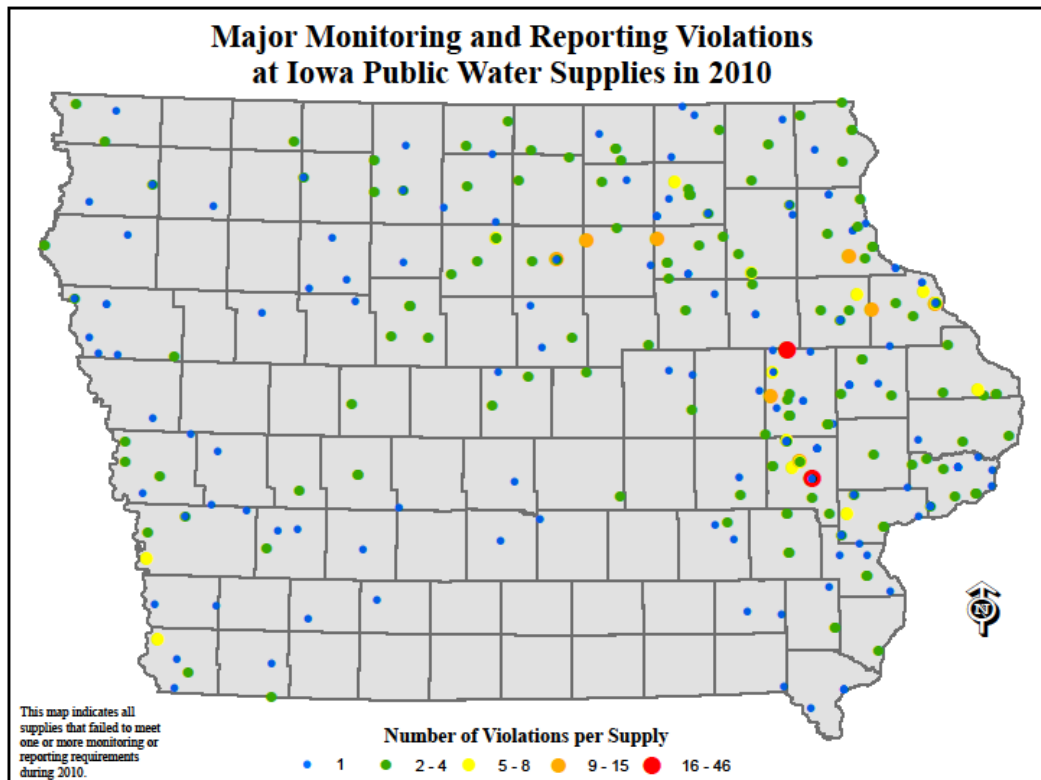

The National Public Drinking Water Program: An Overview

The United States Environmental Protection Agency (EPA) established the Public Water System Supervision Program under authority of the 1974 Safe Drinking Water Act (SDWA), which was most recently amended in 1996.

- To ensure the water is safe for human consumption, EPA sets national limits on allowable contaminant levels in public water supply systems. These limits are known as maximum contaminant levels and maximum residual disinfectant levels.
- Because certain contaminants are difficult to measure, EPA establishes treatment techniques or action levels in lieu of a maximum contaminant level to control unacceptable levels of those specific contaminants in public drinking water.
- EPA specifies how often systems must monitor for contaminants and requires those monitoring results be reported to the state. Generally, the larger the population, the more frequent the monitoring and reporting requirements.
- EPA requires systems to notify the public they serve when violations of the drinking water regulations occur. Public notification must include a clear and understandable explanation of the nature of the violation, potential adverse health effects resulting from the violation, steps the system is taking to correct the violation, and the availability and necessity of using alternative water supplies until the violation is corrected.
- EPA also has requirements for certification of water distribution and water treatment operators, environmental laboratory certification, and development of systems' technical, financial, and managerial capacity, to ensure that systems are properly operated.

The SDWA applies to all 50 States, the District of Columbia, Native American Indian Lands, Puerto Rico, the Virgin Islands, American Samoa, Guam, and the Commonwealth of the Northern Mariana Islands.

The SDWA allows States and Territories to seek EPA approval to administer the Public Water Supply Supervision Program within their state or territory, which is called primacy. To receive primacy, States must meet certain requirements set forth in the SDWA regulations, including adoption of drinking water regulations which are at least as stringent as federal regulations, and must demonstrate that the state or territory can enforce the program requirements. Of the 56 states and territories, all but Wyoming and the District of Columbia have primacy. The EPA Regional Offices administer the PWSS programs within those two jurisdictions.

Native American tribes must meet the same requirements as a state in order to receive primacy. EPA currently administers PWSS Programs on all Indian lands except the Navaho Nation, which was granted primacy in 2000. The three public water supplies operated by Native American tribes in Iowa have not received primacy and are overseen directly by EPA Region 7 (Kansas City): Winn-A-Vegas Casino in Sloan; CasinOmaha in Onawa; and, the Sac & Fox Community in Tama.

EPA regional offices report to the states any enforcement actions taken by EPA within their jurisdiction. All SDWA data for a state is stored in an electronic database called the Safe Drinking Water Information System (SDWIS). This database contains an inventory of public water supply systems and violation records. States have additional computer systems to augment the required functions of the SDWA program.

The IDNR Drinking Water Program Components

The Iowa public drinking water program has the following responsibilities, conducted by staff located centrally in Des Moines (Water Supply and Region 5), as well as in six other cities around the state: Manchester (Region 1), Mason City (Region 2), Spencer (Region 3), Storm Lake (Satellite Office 3A), Atlantic (Region 4), and Washington (Region 6). The offices are shown on the map at the right.

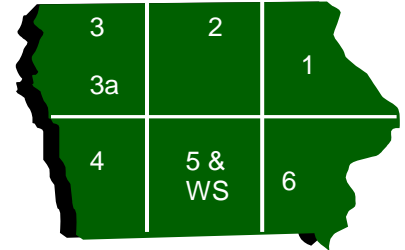

On-Site Inspection

- conducts site surveys for well and treatment facility placement,
- along with contracted county health departments, inspects every public water supply system in the state at least every five years (three years for community water systems), which includes examination of the operation and maintenance of the entire system,
- provides technical assistance to water supply operators,
- responds to complaints from the public,
- provides emergency response to spills that may threaten water resources,
- provides emergency response assistance to public water supply systems during disaster events

Operation Permitting

- issues the operation permits for each system at least every three years, which lists the system-specific monitoring and operation requirements,
- provides technical assistance to water supply operators,
- monitors the compliance by each system with the drinking water program requirements,
- prepares violation notices, compliance schedules, and enforcement actions

Construction Permitting

- issues construction permits for projects,
- reviews preliminary engineering reports and viability assessments,
- assists systems and consulting engineers in selecting various treatment technologies for specific water quality problems.

Water Allocation and Use Permitting

- allocates and tracks the withdrawal of water from Iowa's aquifers and surface waters,
- issues and renews water use permits that are effective for ten years, and
- reviews water conservation plans.

Drinking Water Operator Certification

- evaluates qualifications of the applicants to determine eligibility for examination,
- certifies operators that successfully complete a written exam,
- renews certification of operators that earn continuing education units.

Environmental Laboratory Certification

- certifies laboratories that analyze compliance samples under the SDWA,
- contracts with the University (of Iowa) Hygienic Laboratory to inspect environmental laboratories every two years and check the accuracy of annual proficiency testing samples.

Drinking Water State Revolving Loan Program (DWSRF)

- makes low-interest loans to drinking water systems for construction of drinking water sources, treatment, storage and distribution systems to ensure public health and provide safe drinking water,
- conducts environmental reviews,
- makes low-interest loans for implementation of source water protection projects,
- if there are more requests than funding, scores and ranks applications based on whether the projects addresses health risks, rule compliance, infrastructure needs, and source water protection including criteria for loan eligibility. Since 2000, more than \$491 million has been loaned through the DWSRF to Iowa public water supply systems.

Iowa also provides a variety of assistance to public water systems through the following programs, funded through the state revolving loan fund set-asides:

- **Capacity Development** The department continues to implement a capacity development (also called viability assessment) strategy to improve the financial, technical, and managerial capabilities of all water systems. New systems must be considered viable before they start construction and begin operating. Existing systems are required to conduct self-assessments based upon various performance factors and may need to work with the department on areas determined to be deficient in order to retain viable status. The department has an e-mail newsletter (listserv) written for operators on relevant topics of the day. The listserv is sent at least monthly to the subscribers, which numbered 887 people at the end of June 2011.
- **Area Wide Optimization Program (AWOP)** In 2006, the department began participating in the AWOP program, a national program designed to assist water utilities in optimizing the performance of their existing treatment facilities, as part of the state's capacity development strategy.
 - During 2010, the department initiated its second Microbial Performance-Based Training series with eight surface water treatment plants and eight department staff serving as facilitators for the plants. Plant staff learned about the importance of setting optimization goals in Session 1, were introduced to the concept of using special studies to investigate solutions to operational challenges at their plants in Session 2, and learned how to calibrate and use a jar test as a mini "pilot plant" in Session 3.
 - As part of a continuing commitment to the provision of training for all surface/influenced ground water system operators, department staff held a Surface Water Workshop in March of 2010 in Des Moines. This workshop introduced key principles of distribution system optimization such as the use of chlorine residual as a surrogate for water quality and tank mixing, in addition to updates on more traditional optimization topics.
 - The AWOP team conducted four visits to surface water plants to verify CT (contact time) calculations and provide technical assistance.
 - In September, Iowa hosted the EPA Region 6 states for a quarterly AWOP meeting and hosted a distribution field event in Urbandale, Iowa. This event focused on the use of hydrant and tap samplers to collect representative chlorine residual samples in the distribution system.
 - In December, the department hosted a one-day training session for surface water system operators and state staff on the calibration and use of analytical equipment for turbidity, chlorine, and chloramines.
 - Throughout the year, the department also continued to work with EPA and its contractor on a pilot program to fully integrate AWOP with the rest of the drinking water program.
- **Source Water Protection** The first step in a multiple-barrier approach to drinking water protection is preventing contamination of drinking water sources. The Iowa Geological Survey continues to

perform source water delineation and contaminant source inventory assessments for new public water sources, which the systems may then use to develop their system-specific source water protection plans. The primary emphasis of the Source Water Protection program now focuses on the implementation of local source water protection activities and projects. This program was moved to the IDNR's Iowa Geological & Water Survey Bureau in 2007.

- **Public Water System Security** The department provides information, consultation, and training to public water systems and operators regarding drinking water security.
- **Technical Assistance Contracts** The department administers contracts for projects that provide technical assistance to water operators and to systems serving fewer than 10,000 persons.

Photos of the AWOP and PBT activities in 2010:



Multi-state AWOP Training Event: Using a hydrant sampler for mapping the chlorine levels in the distribution system



PBT 2010: Classroom Instruction



PBT Training 2010: Filter Bed Expansion Evaluation



PBT Training 2010: Special Study



PBT 2010: Jar Test Calibration Training

Photo credits by DNR staff

Iowa's Public Water Supply Systems

Definition of a Public Water Supply System (PWS)

A public water supply system is a system that provides water to the public for human consumption. The system must have at least 15 service connections or regularly serve an average of at least 25 individuals daily at least 60 days out of the year. An example of a system that is not a public water supply (a private water supply) would be a well serving a farmstead or rural home with 6 residents.

A public water supply system (PWS) is either a community water system, a non-transient non-community system, or a transient non-community system.

- A **community water system** (CWS) is a PWS that meets the above definition for year-round residents. Examples of CWSs include municipalities, subdivisions, and mobile home parks.
- A **non-transient non-community water system** (NTNC) is a PWS that regularly serves at least 25 of the same people four hours or more per day, for four or more days per week, for 26 or more weeks per year. Examples of these systems are schools, day-care centers, factories, and offices. Other service-oriented businesses, such as hotels, resorts, hospitals, and restaurants, are classified as NTNCs if they employ 25 or more people and are open for 26 or more weeks of the year.
- A **transient non-community water system** (TNC) is a PWS other than a CWS or NTNC that regularly serves at least 25 individuals daily at least 60 days out of the year. Examples of TNCs are convenience stores, bars, restaurants with fewer than 25 employees, golf courses, camps, parks, and recreation areas.

Public Water Supply Systems in Iowa

Number of Systems

In 2010, over 2.71 million Iowans were served by community public water supplies, or 88.9% of the total state population (2010 census of 3,046,355), with the remaining 11.1% of the population served by private water supplies. Iowa's 1,966 public water supply systems in 2010 included 1,131 CWS, 139 NTNC, and 696 TNC systems. The map depicting all of Iowa's active public water supply systems in 2010 is shown on the next page.

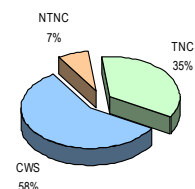

System Size

Iowa is a small-system state, as indicated in the following table, with 94% of our systems each serving fewer than 3,300 people.

Population Served	EPA Classification	Number of Iowa PWS	Percentage of Total Number of PWS	Total Population Served
25 – 500	Very Small	1,396	71.0	191,142
501 – 3,300	Small	444	22.6	546,035
3,301 – 10,000	Medium	81	4.1	466,537
10,001 – 100,000	Large	42	2.1	1,151,874
Over 100,000	Very Large	3	0.2	485,053
Total		1,984	100.0	2,840,641

Number of Regulated Iowa PWSs: 2001 - 2010

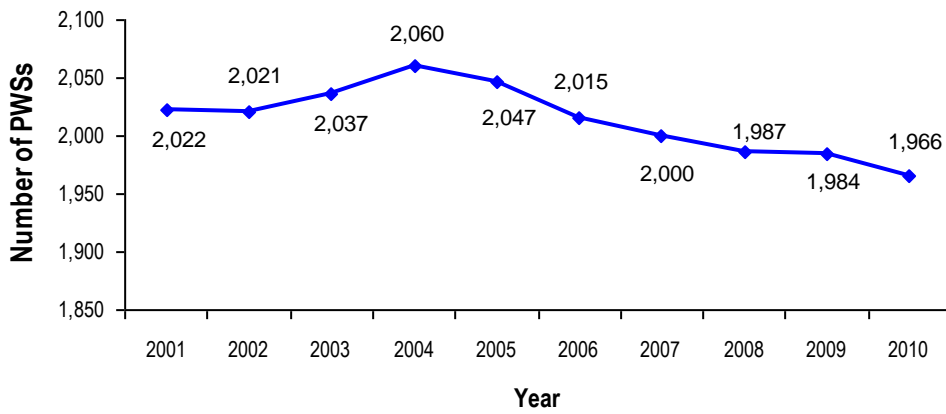

In 2010, the number of public water supply systems in Iowa continued the downward trend from 2004. Any system that was active for a single day during the year is included in that year's total.

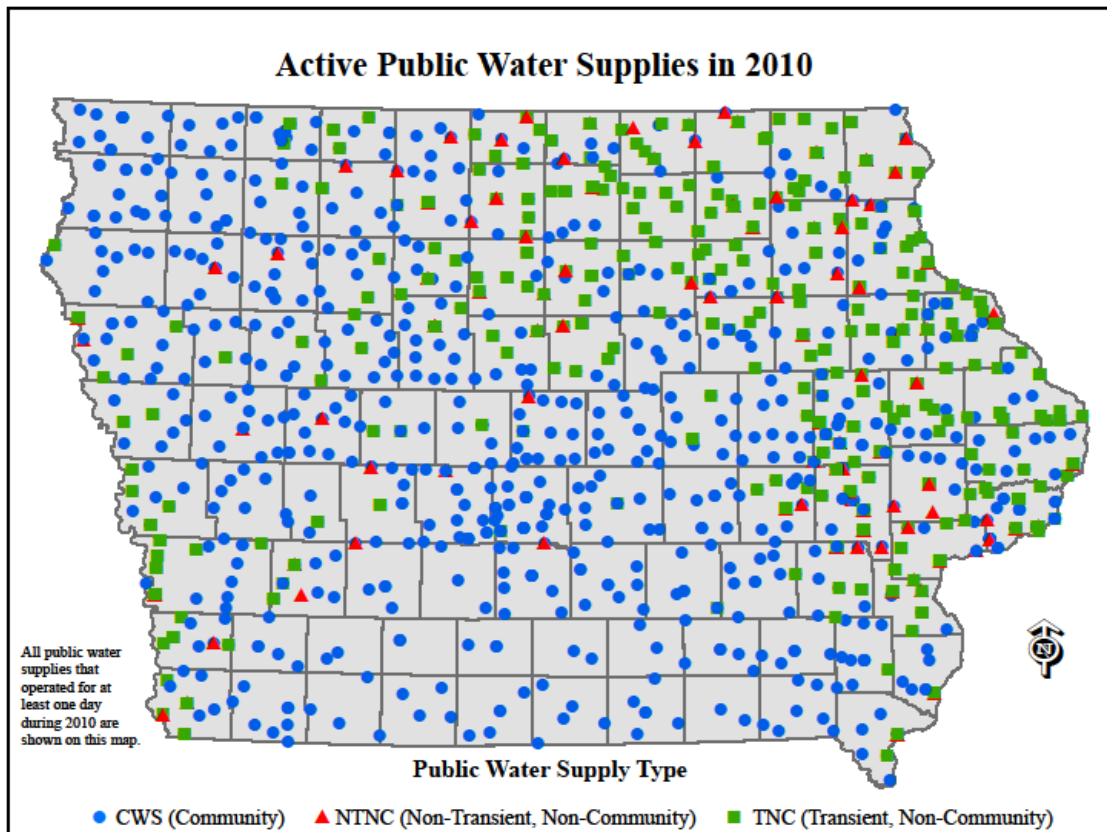

System Source Water

Iowa's drinking water is obtained from three sources:

- Groundwater from deep or shallow wells,
- Surface water from rivers, lakes, and reservoirs, and
- Groundwater that is under the direct influence of surface water as determined through testing by the presence of insects, bacteria, algae, pathogens, and/or significant and relatively rapid shifts in physical and chemical water characteristics.

Since a PWS can use any combination of water sources in its system, the PWS is classified by the source that is most vulnerable to contamination. Surface water systems are most vulnerable to contamination, followed by influenced groundwater systems. As indicated in the following tables, 92% Iowa's systems are served by groundwater sources, which serve 55% of the population. Surface water and influenced groundwater sources are used in the remaining 8% of systems, yet they serve 45% of the population.

Source of Water	Number of PWS	Percentage of Total PWS	Percentage of Total Population Served
Surface water	129	6.6	35.1
Influenced Groundwater	28	1.4	10.3
Groundwater	1,809	92.0	54.6

Systems using surface water or influenced groundwater sources have more complex operational and monitoring requirements than do groundwater systems, because of the greater treatment requirements of their source water.

System Source Water in Iowa:

The vast majority of Iowa's systems are supplied by groundwater.

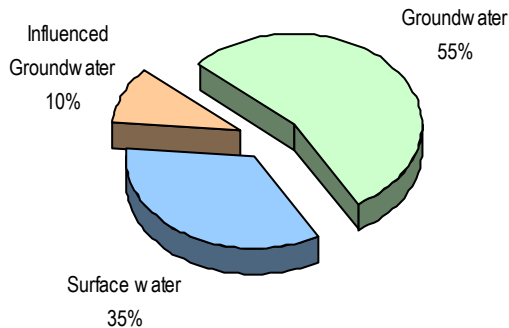
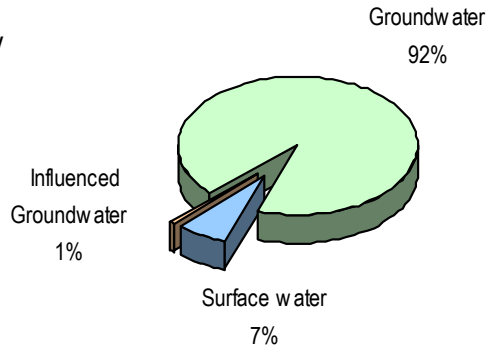

Population Served by the various Source Waters:

Even though 92% of Iowa's systems use groundwater, only 55% of the state's population is served by groundwater systems. The more populated areas of the state are generally served by surface water or influenced groundwater sources.

Maximum Contaminant Levels (MCLs) and Maximum Residual Disinfectant Levels (MRDLs)

All systems classified as public water supplies are required to test periodically for coliform bacteria, nitrate, and nitrite. Inorganic and organic chemical testing are only required in community and non-transient non-community systems. With the exception of chlorine, chloramines, and chlorine dioxide, the contaminants are regulated by a specific maximum contaminant level (MCL). An MCL is defined as the maximum permissible level of a contaminant in water that is delivered to any user of a PWS. Chlorine, chloramines, and chlorine dioxide are regulated by a maximum residual disinfectant level (MRDL), defined as the level of a disinfectant added for water treatment that may not be exceeded at the consumer's tap without an unacceptable possibility of adverse health effects.

With both the MCL and MRDL, if the drinking water meets that limit for a specific contaminant, it is considered to be safe.

In this section, the requirements for each group of contaminants are described, including the type of violation, common sources of contamination, specific health effects, how a violation is incurred, and how the system returns to compliance. The rules pertaining to MCLs and MRDLs are listed in the Iowa Administrative Code 567—Chapters 40, 41, 42, and 43.

Contaminants posing an immediate risk to human health (Acute)

There are five regulated contaminants that may pose an immediate, or acute, risk to human health if they are found in drinking water: fecal coliform bacteria, *E. coli*, nitrate, nitrite, or chlorine dioxide.

Coliform Bacteria, including fecal coliform bacteria and *E. coli*—567 IAC 41.2(1)

Sources of Contamination: Total coliform bacteria are common in the environment and are generally not harmful themselves. Fecal coliform bacteria and *E. coli* are generally not harmful themselves, but their presence in drinking water is serious because they usually are associated with sewage or animal waste. The presence of these bacteria in drinking water generally is a result of a problem with water treatment or the pipes which distribute the water, and indicates that the water may be contaminated with organisms that can cause disease (pathogens).

Health Effects: At greatest risk are children, pregnant women, infants, elderly persons, and persons with compromised immune systems. Disease symptoms may include diarrhea, cramps, nausea, headaches, and fatigue. Chlorinating the drinking water will provide disinfection. Boiling water in the home is also an effective method of sterilizing the drinking water.

Acute MCL: When total coliform bacteria are present in any sample, that sample is also analyzed for fecal coliform bacteria or *E. coli*. Any confirmed fecal coliform bacteria or *E. coli* sample is a violation of the MCL for total coliform bacteria. To meet this MCL, all drinking water samples must be free of these bacteria.

Violation: A PWS incurs a violation when the MCL is exceeded in any one monthly or quarterly compliance period. A violation of the acute coliform bacteria MCL is an acute violation and public notification must be started within 24 hours of notification of the violation.

Compliance Achieved: The system returns to compliance when all analytical results are below the MCL for a period of six consecutive months, and all required samples are collected as directed.



Nitrate and Nitrite—567 IAC 41.3

Source of Contamination: Nitrate and nitrite contamination can occur from several sources: the natural decay of organic materials such as leaves and crop residue, use of commercial fertilizers, contamination by human sewage and wastes from farm animals, and the nitrification of ammonia in the treatment and distribution system.

Health Effects: Excessive levels of nitrate and nitrite in drinking water can cause serious illness and sometimes death in infants less than six months of age. Nitrate converts to nitrite, which interferes with the oxygen-carrying capacity in the child's blood (methemoglobinemia or blue-baby syndrome). This is an acute disease because symptoms can develop rapidly in infants. In most cases, health deteriorates over a period of days. Symptoms include shortness of breath and blueness of the skin. Expert medical advice should be sought immediately if these symptoms occur. Boiling the water will only concentrate nitrates in drinking water, and should not be attempted. Alternative sources of water should be used, such as Food and Drug Administration (FDA) approved bottled drinking water with low levels of nitrate clearly listed on the packaging.



Acute MCL: The MCL for nitrate is 10 mg/L as N and the MCL for nitrite is 1.0 mg/L as N.

Violation: A system incurs a violation when the MCL is exceeded in any one compliance period, assigned either as a monthly, quarterly, or annual requirement. Violation of the nitrate or nitrite MCL is an acute violation.

Compliance Achieved: The system returns to compliance when all analytical results are below the MCL for a period of six consecutive months, and all required samples are collected as directed.

Chlorine Dioxide—567 IAC 41.6

Source: Chlorine dioxide is a chemical added to drinking water for the purposes of microbial disinfection and oxidation of dissolved organic carbon (to reduce formation of disinfection byproducts).

Health Effects: Some infants and young children who drink water containing chlorine dioxide in excess of the MRDL could experience nervous system effects. Similar effects may occur to the fetuses of pregnant women who drink water containing chlorine dioxide in excess of the MRDL. Some people may experience anemia. Violations of the chlorine dioxide standard within the distribution system may harm human health based on short-term exposures. Certain groups, including fetuses, infants, and young children, may be especially susceptible to nervous system effects from excessive chlorine dioxide exposure.

Acute MRDL: The MRDL for chlorine dioxide is 0.8 mg/L as ClO₂, and only applies to those systems using chlorine dioxide in their treatment processes. An acute MRDL occurs when too much of the chlorine dioxide is applied during the treatment process at the treatment plant.

Violation: A system incurs an acute violation when the daily monitoring results in the distribution system exceed the MRDL on the day following an elevated chlorine dioxide level at the entry to the distribution system.

Compliance Achieved: The system returns to compliance when the analytical results are below the MRDL for a period of six consecutive months, and all required samples are collected as directed.

Contaminants posing a long-term risk to human health (chronic or non-acute)

Total Coliform Bacteria—567 IAC 41.2(1)

Source of Contamination: Total coliform bacteria are common in the environment and are generally not harmful themselves, but their presence in drinking water is serious because it indicates a pathway of contamination. The presence of these bacteria in drinking water generally is a result of a problem with

water treatment or the pipes which distribute the water, and indicates that the water may be contaminated with organisms that can cause disease.

Health Effects: At greatest risk are children, pregnant women, infants, elderly persons, and persons with compromised immune systems. Disease symptoms may include diarrhea, cramps, nausea, headaches, and fatigue. Chlorinating the drinking water will provide disinfection. Boiling water in the home is also an effective method of sterilizing the drinking water.

Non-Acute MCL: Compliance with the MCL is determined by the presence or absence of total coliform bacteria in a sample. Any confirmed total coliform sample, with no detection of fecal coliform or *E. coli*, is a violation of the MCL for total coliform bacteria. To meet this MCL, all drinking water samples must be free of total coliform bacteria.

Violation: A system incurs a violation when the MCL is exceeded in any one compliance period assigned either as a monthly or quarterly requirement.

Compliance Achieved: The system is returned to compliance when all results are below the MCL for a period of six consecutive months, and all samples are collected as directed.

Inorganic Chemicals—567 IAC 41.3 (not including lead & copper)

Source of Contamination: Inorganic contaminants can leach into drinking water after dissolving from naturally-occurring minerals in the ground, or from runoff from industrial sources or landfills. Chlorite and bromate are byproducts of disinfection.

Health Effects: These contaminants may damage organs such as the kidneys and liver, damage the cardiovascular system and central nervous system, and are sometimes associated with high blood pressure and cancer. High levels of fluoride may cause dental and skeletal fluorosis.

Non-Acute MCL: Compliance with the MCL is determined based upon the sampling frequency:

- For systems collecting a sample every month or quarter, compliance with the MCL is determined using a running annual average.
- For systems collecting a sample annually or longer in frequency, compliance with the MCL is determined using the average of the initial sample and a confirmation sample.

Compliance with the chlorite requirements for systems using chlorine dioxide is determined from both source/entry point and distribution system samples.

Violation: A PWS incurs a violation when the MCL is exceeded in the average of the required samples.

Compliance Achieved: The system is returned to compliance when it has no monitoring or MCL violations for a period of six consecutive months.

Organic Chemicals—567 IAC 41.5

Organic chemicals are classified as a volatile organic chemical [VOC] or a synthetic organic chemical [SOC].

Sources of Contamination: Organic contaminants come from petroleum solvents, paint removers, degreasers, cleaning fluids, pesticides, gasoline, electrical transformers, manufacturing processes, chemical production, byproducts from disinfection, and the production of plastics. Agricultural runoff, improper waste disposal, and improper handling and storage techniques contribute to drinking water contamination via percolation of the contaminant through the soil into the groundwater.

Health Effects: These contaminants may damage organs such as the heart, liver, and kidneys, damage the central nervous and immune systems, and cause cancer.

Non-Acute MCL: Compliance with the MCL is determined based upon the sampling frequency:

- For systems collecting a sample annually or longer in frequency, compliance with the MCL is determined using the average of the initial sample and a confirmation sample.



- For systems collecting a sample every month or quarter, compliance with the MCL is determined using a running annual average.

For contaminants with an established Health Advisory (HA) level but no established MCL, the PWS is required to conduct public notification each quarter in which the HA is exceeded.

Violation: A PWS incurs a violation when the MCL is exceeded in the average of the required samples.

Compliance Achieved: The system is returned to compliance when it has no monitoring or MCL violations for a period of six consecutive months.

Radionuclides—567 IAC 41.8

Source of Contamination: Alpha emitters, which include radium and uranium, occur naturally in certain groundwaters in the state due to the geological formations, particularly in the deeper aquifers. Beta emitters are usually the result of manmade sources or activities.

Non-Acute MCL: Compliance with the MCL is determined from the annual average of four quarters of sampling, either four separately analyzed samples or four temporally composited aliquots.

Health Effects: Radionuclide contaminants may cause cancer.

Violation: A PWS incurs a violation when the MCL is exceeded in the average of the required samples.

Compliance Achieved: The system is returned to compliance when it has no monitoring or MCL violations for a period of six consecutive months.

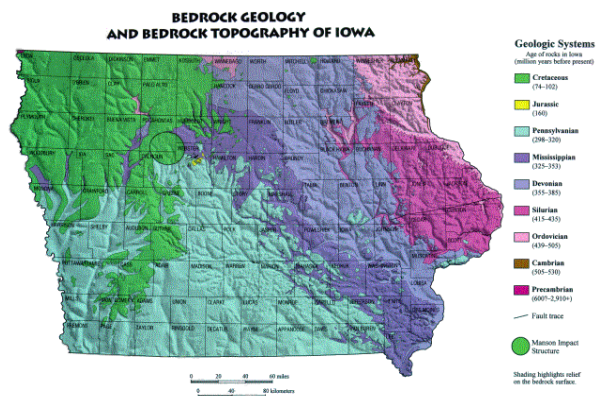

Map courtesy of IDNR Geological Survey

Disinfectants—567 IAC 43.6

Disinfectants are chemicals added to the drinking water during treatment to provide disinfection at the treatment plant and in the distribution system. They are regulated by a maximum residual disinfectant level, MRDL, which is the maximum amount of disinfectant allowed in the system.

Health Effects: Health effects for chlorine and chloramines include irritating effects to the eyes and nose, stomach discomfort, and (chloramine only) anemia. Chlorine dioxide can cause nervous system effects and anemia. Similar effects may occur in fetuses of pregnant women who drink water containing chlorine dioxide in excess of the MRDL.

Non-Acute MRDL: Compliance with the chlorine and chloramine maximum residual disinfectant level (MRDL) is determined from the annual average of twelve months of sampling. Compliance with the chlorine dioxide maximum residual disinfectant level is determined from the comparison of the source/entry point and distribution system samples to the MRDL. Chlorine dioxide can be either an acute (found in the distribution system above the MRDL) or a non-acute health risk (only found at the treatment plant above the MRDL), depending upon the duration and location of the elevated levels in the system.

Violation: A system incurs a violation for chlorine or chloramines when the MRDL is exceeded in the annual average of the required samples. A non-acute violation is incurred for chlorine dioxide when the source/entry point sample exceeds the MRDL for two consecutive days and the distribution system samples are all below the MRDL.

Compliance Achieved: The system is returned to compliance when all results are below the MRDL for a period of six consecutive months, and all samples are collected as directed.

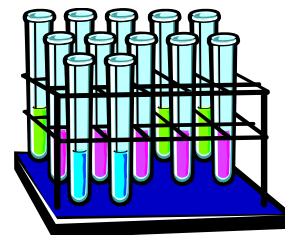

Action Level and Treatment Technique Requirements

Certain systems are required to meet action level and treatment technique requirements. All NTNC and CWS systems are required to comply with the lead and copper action levels. All systems using surface water or influenced groundwater are required to comply with the treatment techniques.

In this section, the requirements for each group of contaminants are described, including the type of violation, common sources of contamination, specific health effects, how a violation is incurred, and how the system returns to compliance. If the drinking water from these systems meets the stated requirements, it is considered to be safe.

Action Level (AL) Requirements

Lead/Copper Action Levels—567 IAC 41.4

Action Level Exceedance: Lead and copper are regulated by action levels (AL) rather than MCL standards. Compliance with the action level is based upon the number of samples collected. The lead action level is exceeded if the concentration of lead in more than 10 percent of tap water samples collected during any monitoring period is greater than 0.015 mg/L (i.e., if the "90th percentile" lead level is greater than 0.015 mg/L). The copper action level is exceeded if the concentration of copper in more than 10 percent of tap water samples collected during any monitoring period is greater than 1.3 mg/L (i.e., if the "90th percentile" copper level is greater than 1.3 mg/L). If the action level at the 90th percentile is exceeded for either lead or copper, it represents a long-term risk to health.

Source of Contamination:

- Lead is a common metal found in lead-based paint, household dust, and certain types of pottery, porcelain, and pewter. It can be found in drinking water due to leaching from lead pipes, from lead solder on indoor plumbing, or from brass faucets and fixtures.
- Copper is often used to plumb residential and commercial structures that are connected to water distribution systems. Leaching of copper from these sources can result in contamination of the drinking water.



Health Effects: Lead builds up in the body over many years and can cause damage to red blood cells and kidneys, as well as damage to the brain, causing mental retardation. Copper at high levels can cause stomach and intestinal distress, liver and kidney damage, and anemia.

Violation: A PWS is out of compliance when the action level is exceeded for either lead or copper in any one compliance period, assigned either as a six-month, annual, or triennial requirement. Once the action level is exceeded, the PWS must collect water quality parameters, develop a corrosion control treatment study, implement steps to control the corrosion in the water, and collect additional samples to demonstrate return to compliance with the action level standard.

Compliance Achieved: A system is returned to compliance when the sample results for two compliance periods are below the action levels for both lead and copper. This can take several years to accomplish due to the time needed to refine corrosion control processes, which is then followed by a year of sampling. Those results must be below the action level before the violation is considered to be compliance achieved.

Treatment Technique Requirements (TT)

EPA established treatment techniques in lieu of MCLs to control unacceptable levels of some contaminants. For example, if a system using surface water or influenced groundwater exceeds the turbidity limit, does not meet the residual disinfectant requirements, or does not meet the disinfection contact time ratio (CT), that system incurs a treatment technique violation. The violation could be either an acute or non-acute violation, depending upon the specific situation.

Surface Water Treatment Rule, Interim Enhanced Surface Water Treatment Rule, and Long-term 1 Enhanced Surface Water Treatment Rule—567 IAC 43.5, 43.9, and 43.10

This rule establishes criteria under which water systems supplied by surface water (SW) or groundwater under the direct influence of surface water (IGW), must filter and disinfect the water during the treatment process. These required treatment techniques are in addition to the other requirements of groundwater systems. All SW/IGW systems have filtration treatment in Iowa.



Treatment Techniques: For purposes of this report, treatment techniques are specified for SW/IGW systems to reduce or remove contaminants that must be monitored at the system and cannot be feasibly or economically measured in a laboratory. The definition of a treatment technique is a treatment process that leads to a reduction in the level of a contaminant sufficient to meet drinking water standards. Examples of treatment techniques for SW/IGW systems are turbidity removal, disinfectant residual maintenance, and sufficient disinfectant contact time.

Turbidity—567 IAC 43.5, 43.9, and 43.10

Treatment Technique: All SW/IGW systems, regardless of size, must meet the treatment techniques for turbidity. Turbidity (or cloudiness) of drinking water is a measure of the minute particles suspended in the water that can interfere with disinfection and testing for bacteria. It can also prevent maintenance of an effective disinfectant residual throughout the distribution system. Systems are required to remove 99% (2-log) of the *Cryptosporidium* oocysts through filtration. In addition, systems using conventional or direct filtration must meet the following two treatment techniques for turbidity:

- the turbidity level of representative samples of a system's filtered water must be less than or equal to 0.3 NTU in at least 95% of the measurements taken each month, and
- no single sample result may exceed 1 NTU.

Sources of Contamination: The major source of turbidity contamination is soil runoff.

Health Effects: Turbidity by itself has no health effects. However, turbidity can interfere with disinfection and provide a medium for microbial growth. Turbidity may indicate the presence of disease-causing organisms such as bacteria, viruses, and parasites such as *Giardia lamblia* and *Cryptosporidium* that can cause symptoms such as nausea, cramps, diarrhea, and associated headaches and can result in death.

Violation: A PWS incurs a treatment technique violation when either standard is exceeded in any month.

Compliance Achieved: A system is returned to compliance when turbidity results consistently meet the standards.

Residual Disinfectant (minimum)—567 IAC 43.5

All SW/IGW systems must provide disinfection to provide inactivation or removal of 99.9% *Giardia lamblia* cysts and 99.99% viruses. The chlorine residual in drinking water is a measure of the amount of available

chlorine in the water. It also allows the maintenance of an effective disinfectant agent throughout the distribution system.

- The disinfectant entering the distribution system cannot be lower than 0.3 mg/L free residual chlorine for more than four hours.
- The disinfectant within the distribution system, measured as total chlorine, combined chlorine, or chlorine dioxide, cannot be undetectable in more than 5% of the samples each month for any 2 consecutive months. This also applies to heterotrophic plate counts (HPC) which can be measured in lieu of disinfectant monitoring. The HPC must be less than or equal to 500 colony forming units per milliliter of sample in order to have acceptable disinfectant residual.

CT Ratio—567 IAC 43.5

All SW/IGW systems must determine their CT value on a daily basis.

- The CT in drinking water is determined by multiplying the disinfectant concentration by the amount of time that the disinfectant is in contact with the water. Each system must achieve a specific CT prior to the treated water entering the water distribution system. The amount of CT required depends on water quality parameters, which include the pH and temperature of the water.
- Insufficient CT can allow disease-causing organisms such as *Giardia lamblia* or viruses to survive and thereby be distributed throughout the system.

Health Effects: CT has no health effects, however, insufficient CT levels can allow disease-causing organisms that can cause symptoms such as nausea, cramps, diarrhea, and associated headaches to survive and enter the distribution system.

Violation: A system incurs a treatment technique violation when the CT ratio or residual disinfectant requirement is insufficient.

Compliance Achieved: A system is returned to compliance when the CT ratio is sufficient and the residual disinfectant requirements have been met. The violation could be returned to compliance in the following month, or the time period could be longer, depending upon the action needed to correct the violation.

Disinfection Byproduct Precursor Removal—567 IAC 43.6

All SW/IGW systems using conventional filtration treatment must determine the removal percentage of disinfection byproduct precursors (organic carbon) on a monthly basis. Failure to remove an adequate percentage is a treatment technique violation. There are alternative compliance criteria that may be used by the system if it is unable to remove the required percentage of total organic carbon. Compliance is determined on running annual average.

Health Effects: Total organic carbon has no health effects, however, it provides a medium for the formation of disinfection byproducts. These byproducts include trihalomethanes and haloacetic acids. Drinking water containing these byproducts in excess of the MCL may lead to adverse health effects, liver, or kidney problems, or nervous system effects, and may lead to an increased risk of getting cancer.

Violation: A system incurs a treatment technique violation when the precursor removal percentage is insufficient and an alternative compliance criteria cannot be used.

Compliance Achieved: A system is returned to compliance when it can meet the precursor removal requirements.



Groundwater Rule—40 CFR 141.400

All public water systems using groundwater (excluding IGW systems in Iowa) are required to comply with the federal Groundwater Rule, which became effective on December 1, 2009. This rule requires microbial

source water monitoring for groundwater systems that do not treat all of their water to at level of least 99.99% (4-log) virus inactivation or removal. Influenced groundwater systems already meet the requirements of this rule because of the mandatory treatment requirements for that source water type. A positive routine total coliform bacteria sample in the distribution system triggers monitoring of the source water in each well that reasonably could have contributed to the positive sample. The source water sample is then analyzed for one of three fecal indicator organisms: *E. coli*, coliphage, or *Enterococci*. Significant deficiencies determined during a sanitary survey must be addressed and corrected within specified timeframes. Systems using approved 4-log virus inactivation or removal treatment in lieu of triggered source water monitoring must also conduct additional disinfectant residual compliance monitoring.

Health Effects: Persons at greatest risk to ill effects from microbial infection are children, pregnant women, infants, elderly persons, and persons with compromised immune systems. Disease symptoms may include diarrhea, cramps, nausea, headaches, and fatigue.

Violation: A system incurs a treatment technique violation when there is a failure in the 4-log virus inactivation treatment or when a significant deficiency in the system is not addressed and corrected within the specified timeframes.

Compliance Achieved: A system is returned to compliance when it meets the required treatment criteria and addresses any significant deficiency that triggers a violation.



Photos of New Wells in 2010



Violation Data for Health-based Standards: MCL, MRDL, AL, and TT

Approximately 2.62 million people received water served by Iowa public water supply systems in 2010 that complied with all health-based standards, including MCL, MRDL, AL, and TT standards. In 2010, 92.1% of the population served by community public water supply systems received water that met all drinking water standards adopted by the department, which was a slight increase from the 2009 level of 91.7%.

Of the 1,966 regulated PWSs in Iowa, 91.0% were in compliance with all MCL, MRDL, AL, and TT standards. There were 176 PWSs that had at least one violation of an MCL, AL, or TT standard. There were no MRDL violations in 2010. There were 351 violations of thirteen contaminants and five treatment techniques in Iowa in 2010, as indicated in the following table. The most frequent standard that was not met in Iowa is coliform bacteria, which, because all systems must monitor for coliform bacteria at least once each quarter, is also the most frequently sampled contaminant in the state.

Analyte	Number of PWS	Number of Violations	Percentage of the Total Number of Violations	Number of Samples Collected in 2010	System Population*
Arsenic	6	10	2.8	207	4,976
Coliform Bacteria, Total	124	205	58.4	55,851	23,015
Coliform Bacteria, Fecal or <i>E. coli</i>	24	26	7.4	11,140	3,858
Chlorite	1	1	0.3	331	4659
Copper	11	12	3.4	3,840	8,579
Contact Time (SWTR) TT	1	1	0.3	Not applicable	124,488
GWR Significant Deficiency TT	1	2	0.6	Not applicable	340
Gross alpha, excluding Rn & U	2	5	1.4	294	160
Gross alpha treatment technique	1	1	0.3	Not applicable	376
Haloacetic Acids 5 (HAA5)	2	5	1.4	1729	4693
Lead	11	12	3.4	3,828	38,673
Nitrate nitrogen	14	29	8.3	3,758	1,387
Nitrate treatment technique	1	1	0.3	Not applicable	28
Nitrite nitrogen	5	24	6.8	649	376
Radium 226 & 228	3	4	1.1	228	551
Total Trihalomethanes (TTHM)	4	10	2.8	1733	9423
Turbidity treatment technique	1	2	0.6	Not applicable	2601
Uranium	1	1	0.3	34	304
Total:	176**	351	100%		225,423**

* The population for a system with multiple violations in a single category was only included once in this total.

** Each PWS is only included once in the total, even though they may have multiple violations. Likewise, the population of a system is only included once in the system population, even though multiple violations may have occurred in a system.

The number of public water supply systems in compliance with all health-based standards continued a similar trend in 2010 as it has over the past decade, as shown in this chart, with the average compliance rate over the ten-year period at 90.7%. However, the number of regulations that the community systems are required to meet has increased substantially during that same time period.

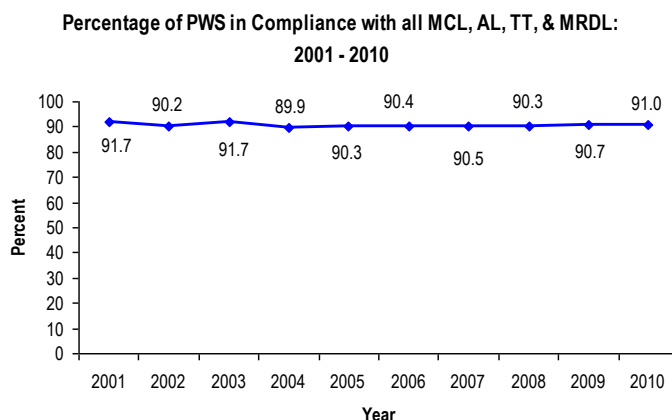

In 2010, the number of systems with violations of health-based standards and the number of violations was little changed from 2009. The majority of the violations occurred in coliform bacteria, nitrate, and disinfection byproducts standards, accounting for 78.6% of the health-based standards violations.

Health-Based Standards Violations: 2001 - 2010

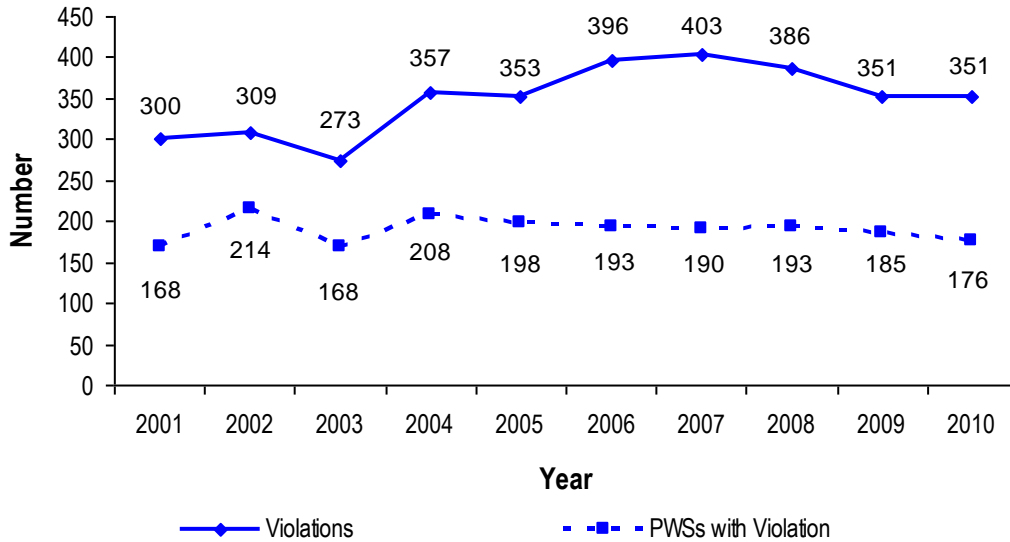

The 2010 data demonstrates a decreased number of non-acute violations and systems with non-acute violations, while the number of acute violations and systems with acute violations both increased.

Coliform Bacteria MCL Violations: 2001 - 2010

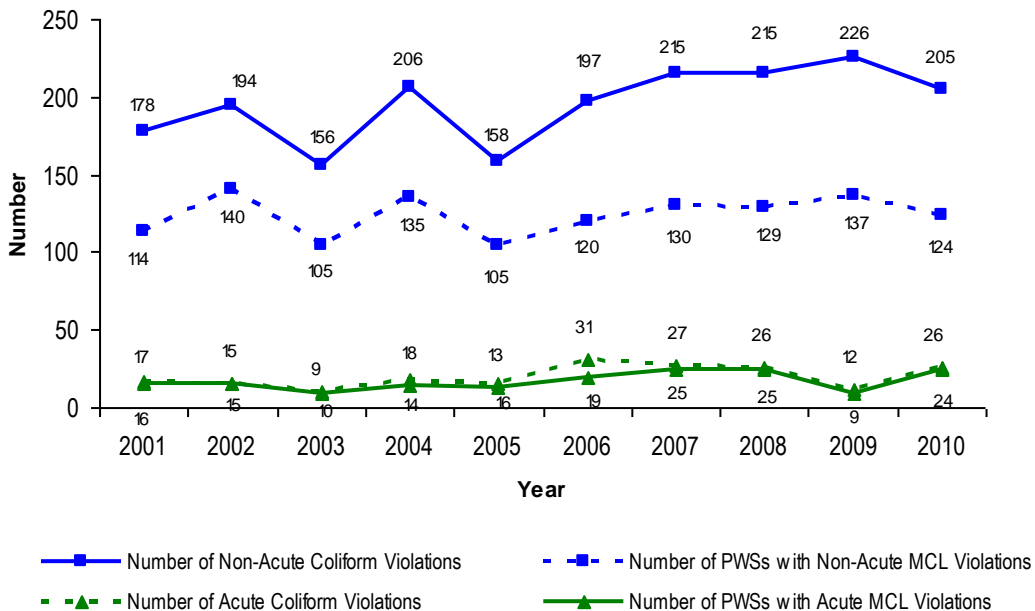

Both the number of nitrate MCL violations and the number of systems with violations were almost unchanged from 2009.

Nitrate MCL Violations: 2001 - 2010

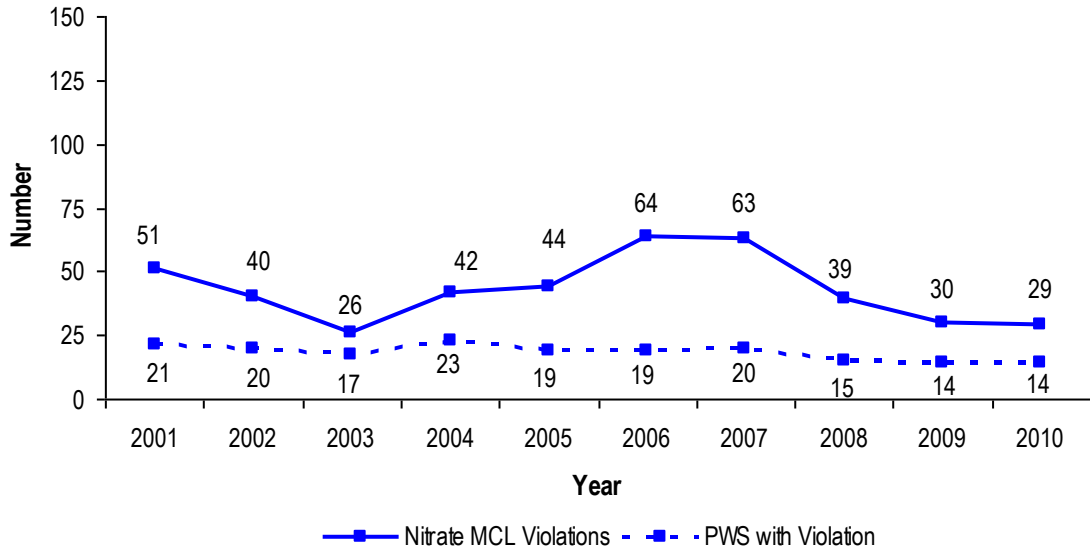

Under the federal Stage 1 Disinfectants/Disinfection Byproducts Rule, large systems (serving at least 10,000 people) were required to start monitoring for disinfection byproducts in 2002, with medium and small systems starting in 2004. Normally a system monitors for a year before an MCL violation can occur, so the first violations started respectively in 2003 and 2005. After peaking in 2005, systems are implementing various techniques to reduce the levels of disinfection byproducts formed in the distribution systems.

Stage 1 Disinfection Byproduct MCL Violations: 2003 - 2010

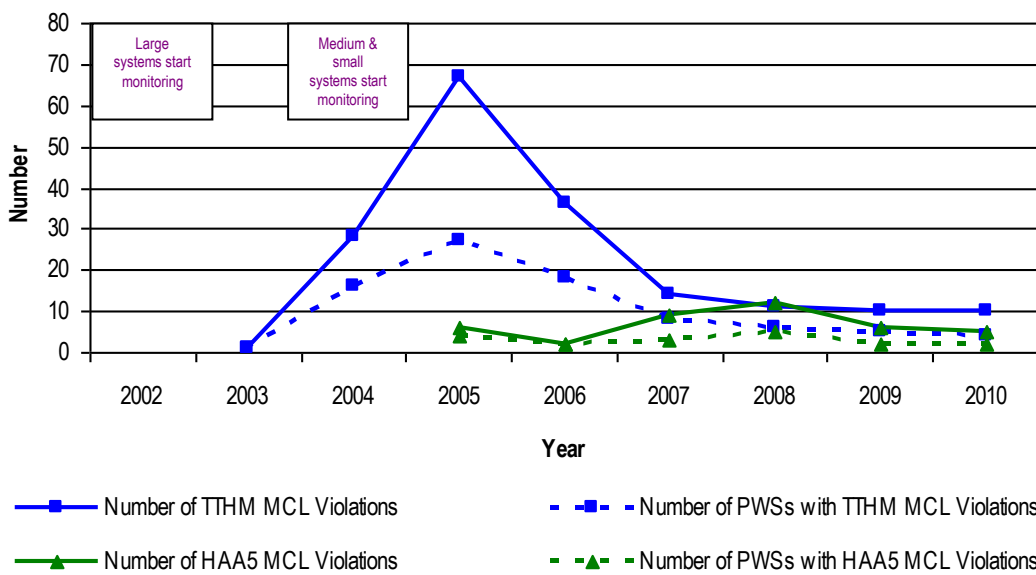

Major Monitoring & Reporting Violations

Monitoring and Reporting (M/R) violations for this report were based on the guidelines briefly described in the next table. EPA deems these violations to be classified as major violations. Minor monitoring violations are those in which at least some of the required monitoring was completed. They are not listed in this report. Systems are assigned the monitoring requirements for each contaminant in an operation permit that is issued at least every three years. The monitoring requirements vary by contaminant, from sampling every four hours (turbidity) to sampling once every nine years (inorganic chemicals). The specific requirements are listed in the Iowa Administrative Code (567) Chapters 41, 42, and 43.

Monitoring Guidelines by Rule:

Rule	Violation Type	Description
Total Coliform Rule and Groundwater Rule	M/R, Routine Major	No samples collected during a compliance period
	M/R, Repeat Major	No follow-up samples collected after a positive sample
Surface Water Treatment Rule, Interim Enhanced Surface Water Treatment Rule, and Long-term 1 Enhanced Surface Water Treatment Rule	M/R, Routine Major	Collected less than 10% of samples required during a compliance period
Lead and Copper Rule	M/R Routine Tap	Failure to collect the initial tap samples followed by a failure to correct that omission within 3 months for large systems, 6 months for medium systems, and 12 months for small systems, or the failure to submit the associated report.
	M/R Routine Tap	Failure to collect any required samples.
Phase I, II, IIB, and V Rules (Inorganic and organic chemicals)	Regular Monitoring	Failure to collect any required samples
Stage 1 Disinfectants & Disinfection Byproducts Rule	M/R, Routine Major	Failure to collect any required samples
Radionuclides	M/R, Routine Major	Failure to collect any required samples
Any Inorganic or Organic Chemical	Confirmation/Check Major	Failure to collect the required confirmation sample.

Out of Compliance: A violation is incurred when the PWS fails to collect, have analyzed, and report the required number of samples in any one compliance period. One violation is issued for each analyte when samples are not collected, analyzed, and reported in accordance with the system's operation permit.

Compliance Achieved: A system is returned to compliance when the samples are collected and the results are reported to the IDNR.

Major Monitoring and Reporting (M/R) Violation Data

Over 2.5 million people received water served by Iowa's systems that met the major monitoring and reporting requirements. Of the 1,966 regulated PWSs in Iowa, 81.6% (1,604 PWSs) were in compliance with all major monitoring and reporting requirements. There were 362 PWSs serving a total population of 284,403 that incurred 757 major monitoring and reporting violations in 2010. The IDNR assigns violations by contaminant for each system, which can result in a single system incurring several monitoring violations.

Listed below are the contaminants with a major monitoring or reporting violation in 2010. The majority of violations were for failure to collect coliform bacteria samples in the distribution system (55.3%) and nitrate samples (19.3%). Coliform bacteria and nitrate are the two contaminants that are required to be sampled by all systems.

Contaminant or Reporting Requirement	Number of PWS	Number of Violations	Population Affected*
Monitoring			
Arsenic	1	1	111
Chlorine	18	19	7,047
Coliform Bacteria, Total (GWR Source Water)	46	55	3,925
Coliform Bacteria, Total (TCR Distribution System)	204	370	39,216
Copper	11	12	10,775
Gross alpha, excluding Rn & U	6	6	1,619
Haloacetic Acids (5)	12	12	11,964
Lead	12	13	10,840
Monthly operational self-monitoring (MOR)	8	9	1,635
Nitrate	93	129	11,669
Nitrite	8	9	2,174
Radium 226 & 228	6	6	2,564
Sodium	7	7	21,495
SOC	3	3	1,237
Total Trihalomethanes	12	12	11,964
Uranium	2	2	742
VOC	4	4	2,263
Monitoring Total:	312*	669	99,472*
Reporting			
Failure to submit monthly operation report	17	19	38,670
Failure to provide consumer confidence report	18	19	4,046
Failure to obtain a construction or operation permit	6	6	90,151
Failure to obtain a certified operator	16	19	5,162
Failure to comply with a compliance schedule	16	16	52,964
Failure to conduct public notice	8	8	644
Failure to have a monitoring plan (DBP)	1	1	340
Reporting Total:	72*	88	189,908
Monitoring & Reporting Total:	362**	757	284,403**

* The population of each PWS is only counted once for each contaminant.

**Each system with a violation is only included once in the number of systems total and the affected population total. To summarize, 362 systems had a total of 757 major monitoring or reporting violations, affecting a total population of 284,403.

Monitoring & Reporting Compliance Rates: 2001 - 2010

The number of public water supplies in compliance with all major monitoring and reporting requirements has fluctuated around the 80.9% average over the past ten years. This chart indicates the percentage of PWS in compliance with all major monitoring and reporting requirements, which was 81.6% in 2010.

Percentage of PWS in Compliance with all Major Monitoring & Reporting Requirements: 2001 - 2010

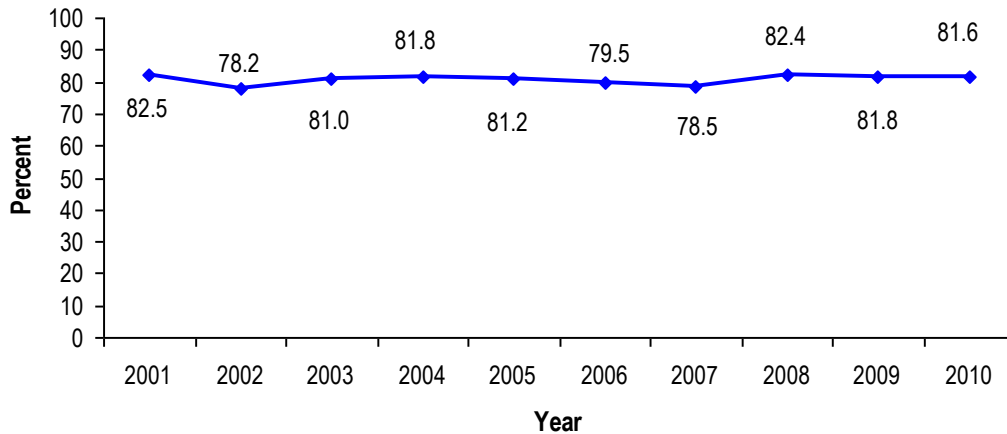

In 2010, the number of systems with monitoring and reporting violations and total number of violations was little changed from the previous two years. The implementation of the federal Groundwater Rule began in December 2009, which accounted for 55 violations at 46 systems in 2010. However, there was no corresponding increase in the overall number of violations or systems with violations, in large part due to the implementation practice that required significant communication efforts amongst the state water supply program staff, system operators, and analytical laboratories to determine the sampling protocols for the source water samples. In 2010, there were 290 systems with 468 triggered events under the Groundwater Rule. With each event, communication was necessary to ensure the correct number of untreated well source water samples were collected at each system, within the very short timeframes required by the rule.

Monitoring & Reporting Violations: 2001 - 2010

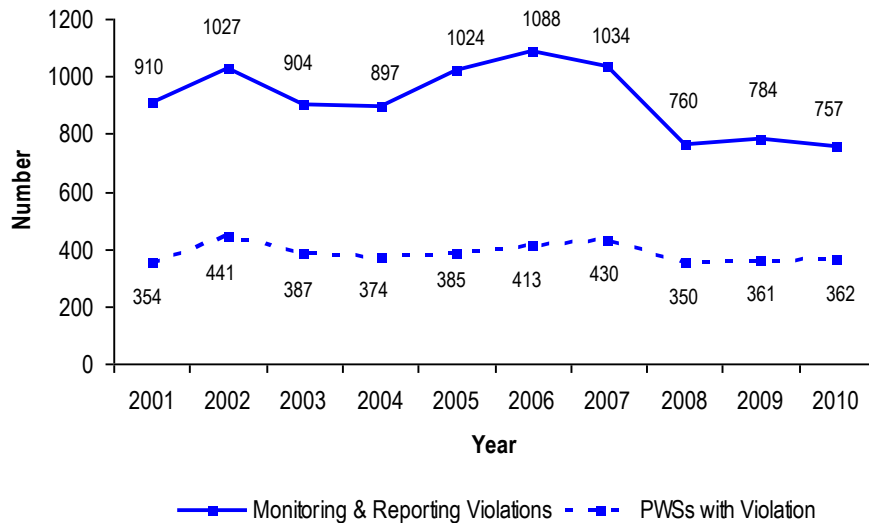

Enforcement Actions

Any time a system incurs a violation, enforcement actions are taken. All systems are issued a notice of violation (NOV), which requires that the public be notified about the violation and any possible health effects. Operation permits are used to list the monitoring and reporting requirements, and also any compliance schedule that the system must meet in order to remedy a violation. The operation permit is termed a "bilateral compliance agreement" or BCA, because the system has a legal right to appeal the document for 30 days, after which time it is binding.

If a system is unable or unwilling to mitigate a violation, an administrative order (AO) is the next enforcement action. An AO may be issued with a monetary penalty or without a monetary penalty. The next level of escalation in enforcement actions is to refer the system to the Iowa Attorney General for enforcement.

All violations remain "open" until the system satisfies the requirements to return it to compliance. In the case of a monitoring violation, returning to compliance may be as simple as collecting the sample that was missed and conducting public notification. In the case where a system has an ongoing health-based standard violation, the system may have to install treatment processes to be able to successfully remove the contaminant from the water. These types of situations can take many months to remedy, and the system is required to conduct public notification at intervals throughout the time period when they are not in compliance with the health standard.

IDNR tracks the corrective actions for all violations at all PWSs. All violations and corrective actions are reported to EPA. When the criteria for compliance are met, the specific violation is coded "Compliance Achieved". Failure to achieve compliance in a timely manner may result in the issuance of an administrative order. These are the most commonly used enforcement actions:

- NOV issued: A notice of violation has been issued to the system by the department.
- PN requested: Public notification for the violation must be done by the system.
- PN received: Public notification has been done by the system and a copy has been received by the department.
- BCA issued: A bilateral compliance agreement between the system and the department has been issued.
- AO w/Penalty: An administrative order with a penalty has been issued by the department.
- AO w/o Penalty: An administrative order without a penalty has been issued by the department.
- AG Case Referred: The system has been referred to the Attorney General's Office for enforcement action.
- Compliance Achieved: The system is now in compliance and the specific violation is "closed".



Most violations have a predefined set of enforcement actions, which include the following four actions at a minimum: notice of violation issued, public notification requested, public notification received, and compliance achieved. Once the PWS has successfully met the compliance achieved criteria, the system is returned to compliance in the department's computerized tracking system.

Variations and Exemptions

Iowa does not use the variance and exemption allowances from EPA.

Public Notification, Lead Public Education, and Consumer Confidence Report—567 IAC Chapter 42

The SDWA requires a system to notify both the people who consume the system's water and the department whenever the following violations occur:

- a Maximum Contaminant Level (MCL) has been exceeded,
- a Maximum Residual Disinfectant Level (MRDL) has been exceeded,
- a required Treatment Technique (TT) has not been achieved,
- the lead Action Level (AL) is exceeded in at least 10 percent of the tap water samples,
- a groundwater sample tested positive for a fecal indicator organism after the triggering positive routine coliform bacteria sample was collected in the distribution system,
- a Compliance Schedule has not been met,
- an EPA Lifetime Health Advisory (HA) has been exceeded,
- a waterborne emergency has occurred,
- a certified operator has not been retained for CWS and NTNC systems, or
- other situations where the department determines that public notification is needed.



MCL, MRDL, or Treatment Technique Violation

To comply with the MCL, MRDL, and TT public notification requirements, the PWS must:

- notify the department within 48 hours after the violation occurred (24 hours for acute violations);
- notify the consumers by the required public notification procedures; and
- provide proof of such public notice including a certification to the department.

Monitoring or Reporting Violation

All PWSs must issue public notification for failure to:

- monitor and report the required data to the department;
- comply with established testing procedures; or
- meet the public notification requirements.



Public Education for a Lead Action Level Exceedance

A PWS must notify the IDNR and the population served by the PWS when the 90th percentile exceeds the action level for lead. This lead public education requires that mandatory language be provided to the consumers every twelve months as long as the action level is exceeded, in the following forms for community systems:

- newspaper announcement;
- pamphlets and brochures to doctors, clinics, schools, daycare facilities, etc.;
- attachments to customers' water bills;
- a notice printed directly on the water bill; and
- a public service announcement must be issued to television and radio for broadcasting.



In addition to the annual notice, a public service announcement must be issued every six months to local television and radio broadcast outlets. Non-transient non-community systems have notification requirements that include posting at the facility plus additional requirements depending upon the composition of their population.

Consumer Confidence Reports

All CWS must notify the public by July 1 of every year with information on the quality of the water delivered by the system in the previous calendar year, and to characterize the risks (if any) from exposure to contaminants in the drinking water. This report, called a Consumer Confidence Report (CCR) or a Water Quality Report, must be prepared by each CWS and made available to their public. The CCR must include the following information:

- source water information;
- definitions of terms used in the report;
- information on detected contaminants (if any were detected), including mandatory language and additional health information where applicable; and,
- whether the system is not in compliance with any other requirement, including monitoring, public notification, operation, administrative order, or operator certification.



Each CWS must mail or otherwise directly deliver one copy of the report to each customer. Mailing waivers are issued to CWS having fewer than 10,000 persons, provided the system had no violations for the covered calendar year. A CWS serving fewer than 500 persons and having a mailing waiver is allowed to publicly post their CCR.

In 2010, 18 CWS failed to prepare and distribute their CCR for calendar year 2009. Each CWS received a reporting violation for this failure. The CCR compliance rate for Iowa's CWS in 2010 was 99.8%.

Lead Consumer Notice

The CWS and NTNC systems are required to provide a Lead Consumer Notice to those consumers who occupy homes or buildings that are part of the system's lead & copper monitoring program. The Notice must be provided within 30 days of the system's receipt of the analytical results, and must include specific mandatory language as well as the analytical lead result from the water sample collected at that home or building.

Health Effects

If a public notification or public education requirement is not met, the public health is placed at risk because the public is unaware of the potential health effects of the water being consumed. Children, pregnant women, the elderly, and persons with compromised immune systems are at the greatest risk from most contaminants.

Public Notification or Public Education Violation

A system is in violation of the public notification or public education rules when it does not issue public notification specific to its violation and does not provide proof of notification to the IDNR. A system is returned to compliance when it publishes the appropriate public notification or public education language within the required amount of time and provides the proof to the IDNR.

Operator Certification—567 IAC Chapter 81

All CWS and NTNC systems are required to have a certified operator in direct responsible charge of the water treatment and water distribution systems. The operators must be certified by the department at the same classification of the plant or water distribution system at a minimum.

The Iowa Operator Certification Program reporting time frame is July 1, 2010 through June 30, 2011.

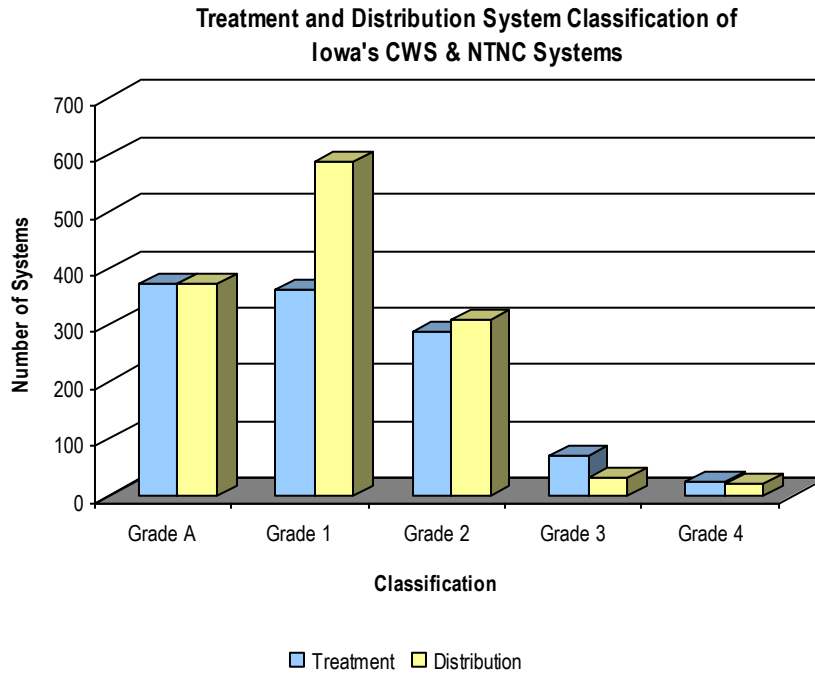

Classification of Systems and Facilities

All CWS and NTNC were required in 2002 to designate a certified operator in direct responsible charge of the water treatment and water distribution systems. The facilities are classified according to complexity, with Grade 4 being the most complex. Listed below are the Iowa CWS and NTNC systems in all classification levels, as of June 26, 2011. There are 206 systems that have a distribution system but no treatment plant.

Classification	Treatment Facility	Distribution Facility
Grade A	373	373
Grade 1	362	587
Grade 2	288	311
Grade 3	68	31
Grade 4	25	20
No facility	0	206
Total	1,116	1,528

Classification Grades for Operator Certification

The Iowa Operator Certification program is predicated on three principles: Education, Experience, and Examination. A certified drinking water operator in Iowa must meet these requirements:

1. Meet the initial education and experience requirements and pay the examination fee
2. Successfully pass the examination for the specific type of certification
3. Maintain the certification by successfully attaining the required continuing education credits during each two-year certification period and paying the bi-annual certification fee

The requirements are based upon the level of complexity of the various facility grades, with Grade A being the least complex and Grade 4 being the most complex.

In this reporting period, there were 297 small system Grade A certifications, which includes both water treatment and water distribution. In this reporting period, there were 2,234 active Grades 1 – 4 water distribution certifications and 2,080 active Grades 1-4 water treatment certifications, both of which increased from the previous year's levels.

Certification Grade	Number of certified Water Distribution Operators	Number of certified Water Treatment Operators
Grade A	297 (combined WT and WD)	
Grade 1	607	739
Grade 2	791	924
Grade 3	536	246
Grade 4	300	171

The following chart depicts the makeup of the two types of drinking water certifications. Note that Grade A is included in both certifications, since it is a combined water distribution and water treatment certification.

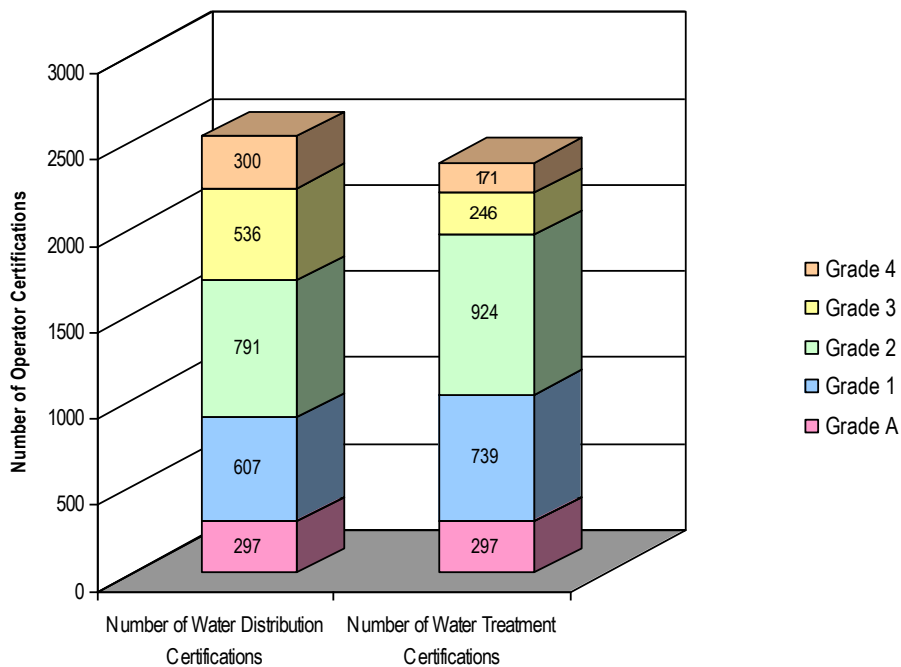

Enforcement

Compliance actions were directed at 16 public water supply systems that failed to have a certified operator in charge of their water supply.

Certification Renewal

Operator certifications are renewed every two years, with the renewal period ending in June 30, 2011. Continuing education requirements must have been met by March 31, 2011, in order for the operator to renew for the next period. Operators holding a Grade A, 1, or 2 certification are required to earn 1.0 continuing education unit (10 contact hours). Operators holding a Grade 3 or 4 certification must earn 2.0 continuing education units (20 contact hours).

More Photos from 2010 DWSRF Projects



New hydrant, emergency generator, & elevated storage tower



New hydrants



Abbreviations

AG	Attorney General of Iowa
AL	action level
AOP	administrative order with penalty
AOWP	administrative order without penalty
BCA	bilateral compliance agreement
CCR	consumer confidence report
CT	contact time
Cu	chemical symbol for copper
CWS	community public water supply
EPA	U.S. Environmental Protection Agency
FDA	U.S. Food and Drug Administration
GW	groundwater
GWR	Groundwater Rule
IGW	groundwater under the direct influence of surface water or influenced groundwater
HA	Health Advisory
HAA5	haloacetic acids (5)
HPC	heterotrophic plate count
IAC	Iowa Administrative Code
IDNR	Iowa Department of Natural Resources
IOC	inorganic chemical
LSL	lead service line
MCL	maximum contaminant level
mg/L	milligrams per liter
M/R	Monitoring and Reporting
MRDL	maximum residual disinfectant level
mrem/yr	millirems per year
NOV	Notice of Violation
NTNC	non-transient non-community public water supply
NTU	nephelometric turbidity units
Pb	chemical symbol for lead
pCi/L	picocuries per liter
PE	public education for Lead
PN	public notification
PWS	public water supply system
PWSS	Public Water System Supervision (EPA program)
Rn	chemical symbol for radon
SDWA	Safe Drinking Water Act
SDWIS/FED	Safe Drinking Water Information System/Federal (EPA's electronic database)
SOC	synthetic (nonvolatile) organic chemical
SW	surface water
SWTR	Surface Water Treatment Rule
TCR	Total Coliform Rule
TNC	transient non-community public water supply
TT	treatment technique
TTHM	total trihalomethanes
U	chemical symbol for uranium
V/E	variance or exemption
VOC	volatile organic chemical
WD	water distribution
WT	water treatment
WQP	water quality parameters

Distribution of this Report

The Safe Drinking Water Act requires both summary and detailed reports from the State be accessible to the U.S. EPA, the Governor of Iowa, and the public. The following options are utilized to make this report readily available to the public.

The IDNR sends the detailed report to the:

- EPA Headquarters in Washington, D.C.,
- EPA Region 7 Headquarters in Kansas City, KS, and
- Office of the Governor of Iowa.

The IDNR also:

- publishes an official notice of report availability,
- includes the report on the IDNR Internet website and makes it available for downloading,
- archives the report in the State Library, and
- makes the detailed and summary report available for individuals and organizations upon request.

Staff Contact Information:

Name	Telephone	Primary Responsibilities	Title
Diane Moles	515/725-0281	Rules and Policy Development	Executive Officer II
Hal Frank	515/725-0342	SDWIS Data Management	Environmental Specialist
Laurie Sharp	515/725-0284	Operator Certification Program	Program Planner 2
Dennis Alt	515/725-0275	Water Supply Engineering Section Supervisor	Env. Program Supervisor
Shelli Grapp	515/725-0401	Water Supply Operations Section Supervisor	Env. Program Supervisor

Fax number for all of the above: 515/725-0348

E-mail addresses: *first name.last name@dnr.iowa.gov*

Mailing address:

Iowa Department of Natural Resources - Water Supply
401 SW 7th St., Suite M
Des Moines, IA 50309-4611



Photo credit: Hal Frank

APPENDIX A: EPA Violations Summary Report

The EPA Violations Summary Report listed in this appendix is a numerical total of the violations of each contaminant required under the SDWA and is a required report element. This report lists the number of violations of each contaminant categorized by both MCL/MRD/TT Violations and major federal Monitoring & Reporting Violations. State violations, such as failure to obtain an operation permit, are not included in this summary report.

Legend

Column (from left to right)	Description of Heading
1	The first column identifies the contaminant name
2	The second column identifies the MCL for that contaminant
3	The third column identifies the number of MCL violations for that contaminant
4	The fourth column identifies the number of PWSs with MCL violations for that contaminant
5	The fifth column identifies the number of TT violations
6	The sixth column identifies the number of PWSs with TT violations
7	The seventh column identifies the number of M/R violations for that contaminant
8	The eighth column identifies the number of PWSs with M/R violations for that contaminant



APPENDIX A: EPA VIOLATIONS SUMMARY REPORT

State: Iowa		Reporting Interval: January 1, 2010 through December 31, 2010					
Organic Contaminants	MCL (mg/L)	MCLs		Treatment Techniques		Significant Monitoring/Reporting	
		Number of Violations	Number of Systems with Violations	Number of Violations	Number of Systems with Violations	Number of Violations	Number of Systems with Violations
1,1,1-Trichloroethane	0.2	0	0	0	0	0	0
1,1,2-Trichloroethane	0.005	0	0	0	0	0	0
1,1-Dichloroethylene	0.007	0	0	0	0	0	0
1,2,4-Trichlorobenzene	0.07	0	0	0	0	0	0
1,2-Dibromo-3-chloropropane (DBCP)	0.0002	0	0	0	0	0	0
1,2-Dichloroethane	0.005	0	0	0	0	1	1
1,2-Dichloropropane	0.005	0	0	0	0	0	0
2,3,7,8-TCDD (Dioxin)	0.00000008	0	0	0	0	0	0
2,4,5-TP (Silvex)	0.05	0	0	0	0	0	0
2,4-D	0.07	0	0	0	0	0	0
Acrylamide		0	0	0	0	0	0
Alachlor (Lasso)	0.002	0	0	0	0	0	0
Atrazine	0.003	0	0	0	0	0	0
Benzene	0.005	0	0	0	0	0	0
Benzo[a]pyrene	0.0002	0	0	0	0	1	1
Carbofuran	0.04	0	0	0	0	0	0
Carbon tetrachloride	0.005	0	0	0	0	0	0
Chlordane	0.002	0	0	0	0	0	0

Organic Contaminants, continued	MCL (mg/L)	MCLs		Treatment Techniques		Significant Monitoring/Reporting	
		Number of Violations	Number of Systems With Violations	Number of Violations	Number of Systems With Violations	Number of Violations	Number of Systems With Violations
cis-1,2-Dichloroethylene	0.07	0	0	0	0	0	0
Dalapon	0.2	0	0	0	0	0	0
Di(2-ethylhexyl)adipate	0.4	0	0	0	0	0	0
Di(2-ethylhexyl)phthalate	0.006	0	0	0	0	3	3
Dichloromethane	0.005	0	0	0	0	0	0
Dinoseb	0.007	0	0	0	0	0	0
Diquat	0.02	0	0	0	0	0	0
Endothall	0.1	0	0	0	0	0	0
Endrin	0.002	0	0	0	0	0	0
Epichlorohydrin		0	0	0	0	0	0
Ethylbenzene	0.7	0	0	0	0	0	0
Ethylene dibromide	0.00005	0	0	0	0	0	0
Glyphosate	0.7	0	0	0	0	0	0
Heptachlor	0.0004	0	0	0	0	0	0
Heptachlor epoxide	0.0002	0	0	0	0	0	0
Hexachlorobenzene	0.001	0	0	0	0	0	0
Hexachlorocyclopentadiene	0.05	0	0	0	0	0	0
Lindane	0.0002	0	0	0	0	0	0
Methoxychlor	0.04	0	0	0	0	0	0

Organic Contaminants, continued	MCL (mg/L)	MCLs		Treatment Techniques		Significant Monitoring/Reporting	
		Number of Violations	Number of Systems With Violations	Number of Violations	Number of Systems With Violations	Number of Violations	Number of Systems With Violations
Monochlorobenzene	0.1	0	0	0	0	0	0
o-Dichlorobenzene	0.6	0	0	0	0	0	0
Oxamyl (Vydate)	0.2	0	0	0	0	0	0
para-Dichlorobenzene	0.075	0	0	0	0	1	1
Pentachlorophenol	0.001	0	0	0	0	0	0
Picloram	0.5	0	0	0	0	0	0
Simazine	0.004	0	0	0	0	0	0
Styrene	0.1	0	0	0	0	0	0
Tetrachloroethylene	0.005	0	0	0	0	0	0
Toluene	1	0	0	0	0	0	0
Total polychlorinated biphenyls	0.0005	0	0	0	0	0	0
Toxaphene	0.003	0	0	0	0	0	0
trans-1,2-Dichloroethylene	0.1	0	0	0	0	0	0
Trichloroethylene	0.005	0	0	0	0	0	0
Vinyl chloride	0.002	0	0	0	0	1	1
Xylenes (total)	10	0	0	0	0	0	0
Haloacetic acids	0.060	5	2	0	0	12	12
Total trihalomethanes	0.080	10	4	0	0	12	12

Inorganic Contaminants	MCL (mg/L)	MCLs		Treatment Techniques		Significant Monitoring/Reporting	
		Number of Violations	Number of Systems With Violations	Number of Violations	Number of Systems With Violations	Number of Violations	Number of Systems With Violations
Antimony	0.006	0	0	0	0	0	0
Arsenic	0.010	10	6	0	0	1	1
Asbestos	7 million fibers/L (>10 µm in length)	0	0	0	0	0	0
Barium	2	0	0	0	0	0	0
Beryllium	0.004	0	0	0	0	0	0
Cadmium	0.005	0	0	0	0	0	0
Chromium	0.1	0	0	0	0	0	0
Cyanide (as free cyanide)	0.2	0	0	0	0	0	0
Fluoride	4.0	0	0	0	0	0	0
Mercury	0.002	0	0	0	0	0	0
Nitrate	10 (as Nitrogen)	29	14	1	1	129	93
Nitrite	1.0 (as Nitrogen)	24	5	0	0	9	8
Selenium	0.05	0	0	0	0	0	0
Sodium	not applicable	0	0	0	0	7	7
Thallium	0.002	0	0	0	0	0	0
Total nitrate and nitrite	10 (as Nitrogen)	NA	NA	NA	NA	NA	NA

Contaminant	MCL	MCLs		Treatment Techniques		Significant Monitoring/Reporting	
		Number of Violations	Number of Systems With Violations	Number of Violations	Number of Systems With Violations	Number of Violations	Number of Systems With Violations
Radionuclide Contaminants							
Gross alpha (excluding Rn & U)	15 pCi/L	5	2	2	1	6	6
Radium-226 and radium-228	5 pCi/L	4	3	0	0	6	6
Gross beta	4 mrem/year	0	0	0	0	0	0
Uranium	30 µg/L	1	1	0	0	2	2
Subtotal		78	37*	2	1	191	136*

*: Each system is only counted once in the subtotal category (i.e., 37 systems had 78 MCL violations and 136 systems had 191 monitoring/reporting violations).

Contaminant	MCL (mg/L)	MCLs		Treatment Techniques		Significant Monitoring/Reporting	
		Number of Violations	Number of Systems With Violations	Number of Violations	Number of Systems With Violations	Number of Violations	Number of Systems With Violations
Other Contaminants							
Acute Total Coliform Bacteria MCL violation	Presence	26	24	0	0	0	0
Non-acute Total Coliform Bacteria MCL violation	Presence	205	124	0	0	0	0
Major routine and follow up Total Coliform Bacteria mon. violation		0	0	0	0	370	204
Major source water monitoring for Fecal Indicator (Groundwater Rule)		0	0	0	0	55	46
Sanitary survey		0	0	2	1	State initiates Sanitary survey	State initiates Sanitary survey
Subtotal		231	124*	2	1	425	216

*Each system is counted only once in the subtotal category, i.e., 124 systems had 231 acute and non-acute coliform bacteria MCL violations.

Contaminant	MCL (mg/L)	MCLs		Treatment Techniques		Significant Monitoring/Reporting	
		Number of Violations	Number of Systems With Violations	Number of Violations	Number of Systems With Violations	Number of Violations	Number of Systems With Violations
Surface Water Treatment Rule, Interim Enhanced SWTR, & LT1 *							
Filtered systems *		0	0	0	0	0	0
Monitoring, routine/repeat		0	0	0	0	0	0
Treatment techniques		0	0	3	2	0	0
Unfiltered systems *		0	0	0	0	0	0
Monitoring, routine/repeat		0	0	0	0	0	0
Failure to filter		0	0	0	0	0	0
Subtotal		0	0	3	2	0	0

* All surface water and influenced groundwater systems in Iowa have filtration.

Contaminant	Action Level	Action Level Exceedance		Treatment Techniques		Significant Monitoring/Reporting	
		Number of Violations	Number of Systems With Violations	Number of Violations	Number of Systems With Violations	Number of Violations	Number of Systems With Violations
Lead and Copper Rule							
Action level exceedance	Lead: 0.015 mg/L Copper: 1.3 mg/L	Lead: 12 Copper: 12	Lead: 11 Copper: 11	2	2	0	0
Initial lead and copper tap M/R		0	0	0	0	0	0
Follow-up or routine lead and copper tap M/R		0	0	0	0	Cu: 12 Pb: 13	Cu: 11 Pb: 12
Treatment installation		0	0	0	0	0	0
Public education		0	0	0	0	0	0
Subtotal		24	20*	2	2	25	12*

*: Each system is only counted once in the subtotal category (i.e., 20 systems had 24 ALE and 12 systems had 25 monitoring/reporting violations).

Contaminant	MRDL or MCL	MRDL or MCL Violations		Treatment Techniques		Significant Monitoring/Reporting	
		Number of Violations	Number of Systems With Violations	Number of Violations	Number of Systems With Violations	Number of Violations	Number of Systems With Violations
Stage 1 DBPR (TTHM & HAA included under Organic Contaminants)						1	1
Chlorine or chloramine residual	4.0	0	0	0	0	19 monitoring 17 reporting	18 monitoring 19 reporting
Chlorine dioxide	0.8 mg/L	0	0	0	0	0	0
Chlorite	1.0 mg/L	1	1	0	0	0	0
Bromate	0.010 mg/L	0	0	0	0	0	0
Total organic carbon (TOC)		0	0	0	0	0	0
Subtotal		1	1	0	0	37	35*

*: Each system is only counted once in the subtotal category (i.e., 35 systems had 37 DBP rule monitoring/reporting violations).

APPENDIX B: Iowa Public Water Supply Violation Data

All public water supply systems that incurred one or more violations during 2010 are listed in the following appendix, including the most recent enforcement action. Systems that became "inactive" during the year because they no longer met the definition of a public water supply are denoted in boldface print on the table.

Legend

Item	Description
PWS Name	Business name of the Public Water System
Minimum Population Served	Population that could use the water, as reported to IDNR by the PWS. For municipal systems, it is the most recent official census.
County	County location of PWS
PWSID Number	Public Water System Identification number, a unique and dedicated number permanently assigned to each PWS
PWS Type	Classification type of PWS: community public water system (CWS), non-transient non-community system (NTNC), or transient non-community system (TNC)
Violation Number	A unique, dedicated identification number assigned to each violation as it occurs.
Analyte	The analyte that triggered the violation.
Compliance Period End Date	Date at the end of the compliance period in which the violation occurred.
Violation	The EPA-assigned text description of the violation.
Violation Type	The alphabetic code description of the violation.
Enforcement Action	Most recent action taken by the PWS or the IDNR in response to the violation. The final action for any violation is "Compliance Achieved," meaning the system is now in compliance.
Enforcement Action Date	Date the follow-up action or enforcement action occurred

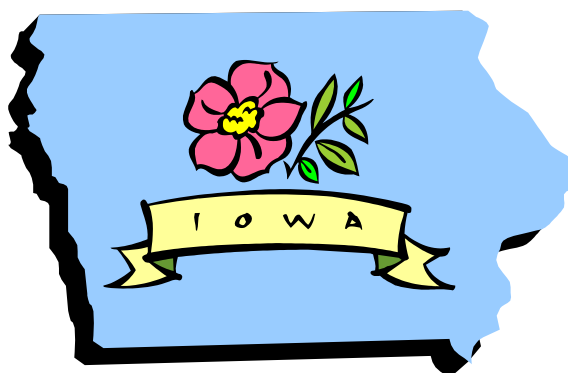

Iowa Public Water Supply System Violations in 2010

Name of the Public Water Supply (Alphabetical Listing)	Minimum Population Served	County	PWSID	PWS Type	Violation Number	Analyte	Compliance End Date	Violation	Violation Type	Enforcement Action	Enforcement Action Date
380 BP, FRESE, INC	258	JOHNSON	IA5285201	TNC	201001962	Coliform, Total (TCR)	30-Sep-10	MCL (TCR), Monthly	MCL	Compliance Achieved	1/10/2011
380 BP, FRESE, INC	258	JOHNSON	IA5285201	TNC	201006536	Coliform, Total (TCR)	31-Aug-10	MCL (TCR), Monthly	MCL	Compliance Achieved	1/10/2011
380 BP, FRESE, INC	258	JOHNSON	IA5285201	TNC	201006616	Coliform, Total (TCR)	30-Sep-10	MCL (TCR), Monthly	MCL	Compliance Achieved	2/1/2011
380 BP, FRESE, INC	258	JOHNSON	IA5285201	TNC	201100047	Coliform, Total (TCR)	30-Sep-10	Monitoring (TCR), Repeat Major	MON	Compliance Achieved	12/20/2010
380 BP, FRESE, INC	258	JOHNSON	IA5285201	TNC	201100280	Coliform, Total (TCR)	11-Sep-10	Monitoring (GWR), Source Major	MON	Compliance Achieved	9/15/2010
380 BP, FRESE, INC	258	JOHNSON	IA5285201	TNC	201100281	Coliform, Total (TCR)	27-Sep-10	Monitoring (GWR), Source Major	MON	Compliance Achieved	12/20/2010
380 BP, FRESE, INC	258	JOHNSON	IA5285201	TNC	201106949	Coliform, Total (TCR)	31-Oct-10	Monitoring (TCR), Routine Major	MON	Compliance Achieved	12/20/2010
380 BP, FRESE, INC	258	JOHNSON	IA5285201	TNC	201107231	Coliform, Total (TCR)	30-Nov-10	Monitoring (TCR), Routine Major	MON	Compliance Achieved	12/20/2010
3RD BASE SPORTS PARK	400	LINN	IA5715204	TNC	201002119	Nitrate (as N)	30-Jun-10	Monitoring (Chem-Rad), Routine Major	MON	Compliance Achieved	8/11/2010
3RD BASE SPORTS PARK	400	LINN	IA5715204	TNC	201002120	Coliform, Total (TCR)	30-Jun-10	Monitoring (TCR), Routine Major	MON	Compliance Achieved	8/11/2010
AIRPORT LAKE PARK-CHICKASAW CCB	50	CHICKASAW	IA1970410	TNC	201001635	Coliform, Total (TCR)	30-Jun-10	MCL (TCR), Monthly	MCL	Compliance Achieved	9/22/2010
AIRPORT LAKE PARK-CHICKASAW CCB	50	CHICKASAW	IA1970410	TNC	201001859	Coliform, Total (TCR)	30-Jun-10	MCL (TCR), Monthly	MCL	Compliance Achieved	9/22/2010
AIRPORT LAKE PARK-CHICKASAW CCB	50	CHICKASAW	IA1970410	TNC	201002029	Coliform, Total (TCR)	30-Jun-10	Monitoring (TCR), Repeat Major	MON	Compliance Achieved	9/22/2010
AIRPORT LAKE PARK-CHICKASAW CCB	50	CHICKASAW	IA1970410	TNC	201002162	Coliform, Total (TCR)	11-Jun-10	Monitoring (GWR), Source Major	MON	Compliance Achieved	6/27/2010
AIRPORT LAKE PARK-CHICKASAW CCB	50	CHICKASAW	IA1970410	TNC	201002171	Coliform, Total (TCR)	30-Sep-10	MCL (TCR), Monthly	MCL	Compliance Achieved	9/22/2010

Name of the Public Water Supply (Alphabetical Listing)	Minimum Population Served	County	PWSID	PWS Type	Violation Number	Analyte	Compliance End Date	Violation	Violation Type	Enforcement Action	Enforcement Action Date
AIRPORT LAKE PARK-CHICKASAW CCB	50	CHICKASAW	IA1970410	TNC	201002267	Coliform, Total (TCR)	31-Aug-10	MCL (TCR), Monthly	MCL	Compliance Achieved	9/22/2010
AIRPORT NATIONAL PUBLIC GOLF COMPLEX	260	LINN	IA5715202	TNC	201100213	Coliform, Total (TCR)	30-Sep-10	Monitoring (TCR), Routine Major	MON	Compliance Achieved	10/4/2010
ALBRECHT ACRES	27	DUBUQUE	IA3183401	TNC	201001689	Fecal Coliform	30-Jun-10	MCL (TCR), Acute	MCL	Compliance Achieved	12/6/2010
ALBRECHT ACRES	27	DUBUQUE	IA3183401	TNC	201001690	Coliform, Total (TCR)	30-Jun-10	MCL (TCR), Monthly	MCL	Compliance Achieved	12/6/2010
ALBRECHT ACRES	27	DUBUQUE	IA3183401	TNC	201006287	Coliform, Total (TCR)	31-Jul-10	Monitoring (TCR), Routine Major	MON	Compliance Achieved	9/23/2010
ALDEN WATER SUPPLY	787	HARDIN	IA4213013	CWS	201001035	Failure to meet Compliance Schedule	01-Feb-10	Compliance Schedule	V/E	Compliance Achieved	2/8/2010
ALGONA COUNTRY CLUB	47	KOSSUTH	IA5502832	TNC	201006506	Coliform, Total (TCR)	30-Sep-10	MCL (TCR), Monthly	MCL	Compliance Achieved	10/28/2010
ALL GOLF CENTER	94	BLACK HAWK	IA0790201	TNC	201100236	Coliform, Total (TCR)	30-Sep-10	Monitoring (TCR), Routine Major	MON	NOV Issued	10/18/2010
ALL GOLF CENTER	94	BLACK HAWK	IA0790201	TNC	201107409	Coliform, Total (TCR)	31-Dec-10	Monitoring (TCR), Routine Major	MON	NOV Issued	1/19/2011
AMERICAN LEGION - SWISHER POST #671	100	JOHNSON	IA5285205	TNC	201001992	Coliform, Total (TCR)	30-Sep-10	MCL (TCR), Monthly	MCL	Compliance Achieved	1/27/2011
AMERICAN LEGION - SWISHER POST #671	100	JOHNSON	IA5285205	TNC	201006455	Coliform, Total (TCR)	31-Aug-10	MCL (TCR), Monthly	MCL	Compliance Achieved	1/27/2011
AMERICAN LEGION - SWISHER POST #671	100	JOHNSON	IA5285205	TNC	201100050	Coliform, Total (TCR)	30-Sep-10	Monitoring (TCR), Repeat Major	MON	Compliance Achieved	10/27/2010
AMERICAN LEGION - SWISHER POST #671	100	JOHNSON	IA5285205	TNC	201100284	Coliform, Total (TCR)	02-Sep-10	Monitoring (GWR), Source Major	MON	Compliance Achieved	10/27/2010
AMERICAN LEGION - SWISHER POST #671	100	JOHNSON	IA5285205	TNC	201107142	Coliform, Total (TCR)	31-Dec-10	MCL (TCR), Monthly	MCL	Compliance Achieved	1/27/2011
AMERITEC MACHINING INC	31	CHICKASAW	IA1970103	NTNC	201107048	Copper	30-Sep-10	Routine/Repeat Tap Sampling (Pb/Cu)	MON	NOV Issued	11/17/2010
AMERITEC MACHINING INC	31	CHICKASAW	IA1970103	NTNC	201107049	Lead	30-Sep-10	Routine/Repeat Tap Sampling (Pb/Cu)	MON	NOV Issued	11/17/2010

Name of the Public Water Supply (Alphabetical Listing)	Minimum Population Served	County	PWSID	PWS Type	Violation Number	Analyte	Compliance End Date	Violation	Violation Type	Enforcement Action	Enforcement Action Date
ANAMOSA TRAVELMART	414	JONES	IA5322201	TNC	201006757	Coliform, Total (TCR)	31-Aug-10	Monitoring (TCR), Routine Major	MON	Compliance Achieved	9/20/2010
ANAMOSA TRAVELMART	414	JONES	IA5322201	TNC	201107400	Nitrate (as N)	31-Dec-10	Monitoring (Chem-Rad), Routine Major	MON	Compliance Achieved	3/28/2011
ANCHOR INN (GARBER)	35	CLAYTON	IA2232776	TNC	201002008	Coliform, Total (TCR)	31-Jul-10	MCL (TCR), Monthly	MCL	Compliance Achieved	12/14/2010
ANCHOR INN (GARBER)	35	CLAYTON	IA2232776	TNC	201002032	Coliform, Total (TCR)	30-Jun-10	Monitoring (TCR), Repeat Major	MON	Compliance Achieved	12/14/2010
ANCHOR INN (GARBER)	35	CLAYTON	IA2232776	TNC	201002164	Coliform, Total (TCR)	24-Jun-10	Monitoring (GWR), Source Major	MON	Compliance Achieved	12/14/2010
ANCHOR INN (GARBER)	35	CLAYTON	IA2232776	TNC	201006415	Coliform, Total (TCR)	29-Jul-10	Monitoring (GWR), Source Major	MON	Compliance Achieved	12/14/2010
ANCHOR INN (GARBER)	35	CLAYTON	IA2232776	TNC	201006725	Nitrate (as N)	31-Aug-10	Monitoring (Chem-Rad), Routine Major	MON	Compliance Achieved	12/14/2010
ANCHOR INN (GARBER)	35	CLAYTON	IA2232776	TNC	201100125	Nitrate (as N)	30-Sep-10	Monitoring (Chem-Rad), Routine Major	MON	Compliance Achieved	12/14/2010
ANCHOR INN (GARBER)	35	CLAYTON	IA2232776	TNC	201100126	Coliform, Total (TCR)	30-Sep-10	Monitoring (TCR), Routine Major	MON	Compliance Achieved	12/14/2010
ANCHOR INN (GARBER)	35	CLAYTON	IA2232776	TNC	201106967	Coliform, Total (TCR)	31-Oct-10	Monitoring (TCR), Routine Major	MON	Compliance Achieved	12/14/2010
ANCHOR INN (GARBER)	35	CLAYTON	IA2232776	TNC	201106968	Nitrate (as N)	31-Oct-10	Monitoring (Chem-Rad), Routine Major	MON	Compliance Achieved	12/14/2010
ANCHOR INN (GARBER)	35	CLAYTON	IA2232776	TNC	201107200	Nitrate (as N)	30-Nov-10	Monitoring (Chem-Rad), Routine Major	MON	Compliance Achieved	12/14/2010
ANCHOR INN (GARBER)	35	CLAYTON	IA2232776	TNC	201107201	Coliform, Total (TCR)	30-Nov-10	Monitoring (TCR), Routine Major	MON	Compliance Achieved	12/14/2010
ANNIES	25	HOWARD	IA4564201	TNC	201107358	Coliform, Total (TCR)	31-Dec-10	Monitoring (TCR), Routine Major	MON	Compliance Achieved	1/26/2011
ARGO GENERAL STORE & DELI	27	SCOTT	IA8245201	TNC	201001610	Coliform, Total (TCR)	30-Jun-10	MCL (TCR), Monthly	MCL	Compliance Achieved	11/29/2010
ARGO GENERAL STORE & DELI	27	SCOTT	IA8245201	TNC	201001700	Coliform, Total (TCR)	30-Jun-10	MCL (TCR), Monthly	MCL	Compliance Achieved	11/29/2010

Name of the Public Water Supply (Alphabetical Listing)	Minimum Population Served	County	PWSID	PWS Type	Violation Number	Analyte	Compliance End Date	Violation	Violation Type	Enforcement Action	Enforcement Action Date
ARGO GENERAL STORE & DELI	27	SCOTT	IA8245201	TNC	201001974	Coliform, Total (TCR)	30-Sep-10	MCL (TCR), Monthly	MCL	Compliance Achieved	11/29/2010
ARGO GENERAL STORE & DELI	27	SCOTT	IA8245201	TNC	201006574	Coliform, Total (TCR)	30-Sep-10	Compliance Schedule	V/E	BCA Signed	7/21/2010
ARGYLE RURAL WATER DISTRICT	175	LEE	IA5603701	CWS	201001541	Gross Alpha, excluding Rn & U	31-Mar-10	Monitoring (Chem-Rad), Routine Major	MON	Compliance Achieved	6/23/2010
AVALON SUPPER CLUB INC.	77	DUBUQUE	IA3128314	TNC	201001096	Coliform, Total (TCR)	31-Jan-10	Monitoring (TCR), Routine Major	MON	Compliance Achieved	3/24/2010
AVALON SUPPER CLUB INC.	77	DUBUQUE	IA3128314	TNC	201001226	Coliform, Total (TCR)	28-Feb-10	Monitoring (TCR), Routine Major	MON	Compliance Achieved	3/24/2010
AVALON SUPPER CLUB INC.	77	DUBUQUE	IA3128314	TNC	201001525	Coliform, Total (TCR)	30-Apr-10	Monitoring (TCR), Routine Major	MON	Compliance Achieved	6/29/2010
AVALON SUPPER CLUB INC.	77	DUBUQUE	IA3128314	TNC	201001746	Coliform, Total (TCR)	31-May-10	Monitoring (TCR), Routine Major	MON	Compliance Achieved	6/29/2010
AVALON SUPPER CLUB INC.	77	DUBUQUE	IA3128314	TNC	201002074	Nitrate (as N)	30-Jun-10	Monitoring (Chem-Rad), Routine Major	MON	Compliance Achieved	8/6/2010
AVENUE OF THE SAINTS OASIS	410	BREMER	IA0990207	TNC	201100226	Coliform, Total (TCR)	30-Sep-10	Monitoring (TCR), Routine Major	MON	Compliance Achieved	10/20/2010
BACKBONE STATE PARK	25	DELAWARE	IA2821906	TNC	201100309	Coliform, Total (TCR)	31-Oct-10	MCL (TCR), Monthly	MCL	Compliance Achieved	5/10/2011
BACKBONE STATE PARK	25	DELAWARE	IA2821906	TNC	201107106	Coliform, Total (TCR)	30-Nov-10	MCL (TCR), Monthly	MCL	Compliance Achieved	5/10/2011
BANCROFT WATER SUPPLY	732	KOSSUTH	IA5507085	CWS	201006365	Coliform, Total (TCR)	31-Jul-10	Monitoring (TCR), Routine Major	MON	Compliance Achieved	8/24/2010
BANKSTON PUBLIC WATER SYSTEM	41	DUBUQUE	IA3109086	TNC	201006730	Coliform, Total (TCR)	31-Aug-10	Monitoring (TCR), Routine Major	MON	Compliance Achieved	9/30/2010
BANKSTON PUBLIC WATER SYSTEM	41	DUBUQUE	IA3109086	TNC	201100139	Nitrate (as N)	30-Sep-10	Monitoring (Chem-Rad), Routine Major	MON	Compliance Achieved	12/11/2010
BANKSTON PUBLIC WATER SYSTEM	41	DUBUQUE	IA3109086	TNC	201107344	Coliform, Total (TCR)	31-Dec-10	Monitoring (TCR), Routine Major	MON	Compliance Achieved	1/28/2011
BAR-L-RANCH	56	GUTHRIE	IA3937444	TNC	201106981	Coliform, Total (TCR)	31-Oct-10	Monitoring (TCR), Routine Major	MON	Compliance Achieved	1/25/2011

Name of the Public Water Supply (Alphabetical Listing)	Minimum Population Served	County	PWSID	PWS Type	Violation Number	Analyte	Compliance End Date	Violation	Violation Type	Enforcement Action	Enforcement Action Date
BAR-L-RANCH	56	GUTHRIE	IA3937444	TNC	201107210	Coliform, Total (TCR)	30-Nov-10	Monitoring (TCR), Routine Major	MON	Compliance Achieved	1/25/2011
BAR-L-RANCH	56	GUTHRIE	IA3937444	TNC	201107355	Nitrate (as N)	31-Dec-10	Monitoring (Chem-Rad), Routine Major	MON	Compliance Achieved	3/15/2011
BAR-L-RANCH	56	GUTHRIE	IA3937444	TNC	201107356	Coliform, Total (TCR)	31-Dec-10	Monitoring (TCR), Routine Major	MON	Compliance Achieved	1/25/2011
BECKER WATER AND ROAD	60	WEBSTER	IA9433312	CWS	201106912	Coliform, Total (TCR)	31-Dec-10	MCL (TCR), Monthly	MCL	Compliance Achieved	1/18/2011
BELLEVUE STATE PK NORTH-NELSON UNIT	506	JACKSON	IA4910939	TNC	201001677	Coliform, Total (TCR)	30-Jun-10	MCL (TCR), Monthly	MCL	Compliance Achieved	12/10/2010
BIG RIVER UNITED ENERGY LLC	51	DELAWARE	IA3130802	NTNC	201001903	Copper	30-Jun-10	AL (Pb/Cu), 90th Percentile	MCL	Compliance Achieved	7/7/2010
BIG RIVER UNITED ENERGY LLC	51	DELAWARE	IA3130802	NTNC	201001904	Lead	30-Jun-10	AL (Pb/Cu), 90th Percentile	MCL	Compliance Achieved	7/7/2010
BIG RIVER UNITED ENERGY LLC	51	DELAWARE	IA3130802	NTNC	201001986	Coliform, Total (TCR)	30-Sep-10	MCL (TCR), Monthly	MCL	Compliance Achieved	1/27/2011
BIG RIVER UNITED ENERGY LLC	51	DELAWARE	IA3130802	NTNC	201002268	Coliform, Total (TCR)	31-Aug-10	MCL (TCR), Monthly	MCL	Compliance Achieved	1/27/2011
BILLION AUTO	185	JOHNSON	IA5225202	NTNC	201107029	Copper	30-Sep-10	Routine/Repeat Tap Sampling (Pb/Cu)	MON	BCA Signed	11/29/2010
BILLION AUTO	185	JOHNSON	IA5225202	NTNC	201107030	Lead	30-Sep-10	Routine/Repeat Tap Sampling (Pb/Cu)	MON	BCA Signed	11/29/2010
BLACK DIAMOND ROADHOUSE	52	JOHNSON	IA5260202	TNC	201002144	Nitrate (as N)	30-Jun-10	Monitoring (Chem-Rad), Routine Major	MON	Compliance Achieved	12/1/2010
BLACK DIAMOND ROADHOUSE	52	JOHNSON	IA5260202	TNC	201002173	Coliform, Total (TCR)	30-Sep-10	MCL (TCR), Monthly	MCL	Compliance Achieved	9/15/2010
BLACK DIAMOND ROADHOUSE	52	JOHNSON	IA5260202	TNC	201006534	Coliform, Total (TCR)	31-Aug-10	MCL (TCR), Monthly	MCL	Compliance Achieved	9/15/2010
BLACK DIAMOND ROADHOUSE	52	JOHNSON	IA5260202	TNC	201107047	Coliform, Total (TCR)	31-Oct-10	Monitoring (TCR), Routine Major	MON	Compliance Achieved	12/1/2010
BLACK DIAMOND ROADHOUSE	52	JOHNSON	IA5260202	TNC	201107235	Coliform, Total (TCR)	30-Nov-10	Monitoring (TCR), Routine Major	MON	Compliance Achieved	12/1/2010

Name of the Public Water Supply (Alphabetical Listing)	Minimum Population Served	County	PWSID	PWS Type	Violation Number	Analyte	Compliance End Date	Violation	Violation Type	Enforcement Action	Enforcement Action Date
BLOOMFIELD MUNI WATER DEPT	2601	DAVIS	IA2613019	CWS	201001043	Total Trihalomethanes (TTHM)	31-Mar-10	MCL (Chem-Rad), Average	MCL	BCA Signed	4/21/2010
BLOOMFIELD MUNI WATER DEPT	2601	DAVIS	IA2613019	CWS	201001044	Total Haloacetic Acids (HAA5)	31-Mar-10	MCL (Chem-Rad), Average	MCL	BCA Signed	4/21/2010
BLOOMFIELD MUNI WATER DEPT	2601	DAVIS	IA2613019	CWS	201001165	Turbidity	31-Jan-10	Monthly Combined Filter Effluent (IESWTR)	TT	Compliance Achieved	3/15/2010
BLOOMFIELD MUNI WATER DEPT	2601	DAVIS	IA2613019	CWS	201001279	Turbidity	28-Feb-10	Monthly Combined Filter Effluent (IESWTR)	TT	Compliance Achieved	3/15/2010
BLOOMFIELD MUNI WATER DEPT	2601	DAVIS	IA2613019	CWS	201001430	Total Trihalomethanes (TTHM)	30-Jun-10	MCL (Chem-Rad), Average	MCL	BCA Signed	4/21/2010
BLOOMFIELD MUNI WATER DEPT	2601	DAVIS	IA2613019	CWS	201001435	Total Haloacetic Acids (HAA5)	30-Jun-10	MCL (Chem-Rad), Average	MCL	BCA Signed	4/21/2010
BLOOMFIELD MUNI WATER DEPT	2601	DAVIS	IA2613019	CWS	201106880	Total Trihalomethanes (TTHM)	30-Sep-10	MCL (Chem-Rad), Average	MCL	BCA Signed	4/21/2010
BLOOMFIELD MUNI WATER DEPT	2601	DAVIS	IA2613019	CWS	201106881	Total Haloacetic Acids (HAA5)	30-Sep-10	MCL (Chem-Rad), Average	MCL	BCA Signed	4/21/2010
BLOOMFIELD MUNI WATER DEPT	2601	DAVIS	IA2613019	CWS	201107284	Total Trihalomethanes (TTHM)	31-Dec-10	MCL (Chem-Rad), Average	MCL	BCA Signed	4/21/2010
BLOOMFIELD MUNI WATER DEPT	2601	DAVIS	IA2613019	CWS	201107285	Total Haloacetic Acids (HAA5)	31-Dec-10	MCL (Chem-Rad), Average	MCL	BCA Signed	4/21/2010
BLUFF LAKE CATFISH FARM	125	JACKSON	IA4950794	TNC	201100075	Coliform, Total (TCR)	30-Sep-10	Monitoring (TCR), Routine Major	MON	Compliance Achieved	10/25/2010
BOYDEN MUNICIPAL WATER SUPPLY	687	SIOUX	IA8409037	CWS	201106898	Copper	30-Sep-10	AL (Pb/Cu), 90th Percentile	MCL	BCA Signed	11/2/2010
BRADDYVILLE WATER WORKS	176	PAGE	IA7324038	CWS	201107012	Copper	30-Sep-10	Routine/Repeat Tap Sampling (Pb/Cu)	MON	NOV Issued	11/19/2010
BRADDYVILLE WATER WORKS	176	PAGE	IA7324038	CWS	201107013	Lead	30-Sep-10	Routine/Repeat Tap Sampling (Pb/Cu)	MON	NOV Issued	11/19/2010
BRADFORD HOUSE	50	CHICKASAW	IA1967222	TNC	201002060	Nitrate (as N)	30-Jun-10	Monitoring (Chem-Rad), Routine Major	MON	Compliance Achieved	7/27/2010
BRAINARDS COUNTRY CHANGE	76	CLAYTON	IA0375301	TNC	201002049	Coliform, Total (TCR)	30-Jun-10	Monitoring (TCR), Routine Major	MON	Compliance Achieved	8/23/2010

Name of the Public Water Supply (Alphabetical Listing)	Minimum Population Served	County	PWSID	PWS Type	Violation Number	Analyte	Compliance End Date	Violation	Violation Type	Enforcement Action	Enforcement Action Date
BRICK CITY	187	BUCHANAN	IA3300770	TNC	201002080	Nitrate (as N)	30-Jun-10	Monitoring (Chem-Rad), Routine Major	MON	Compliance Achieved	2/18/2011
BRICK CITY	187	BUCHANAN	IA3300770	TNC	201002081	Coliform, Total (TCR)	30-Jun-10	Monitoring (TCR), Routine Major	MON	Compliance Achieved	2/18/2011
BRICK CITY	187	BUCHANAN	IA3300770	TNC	201100144	Coliform, Total (TCR)	30-Sep-10	Monitoring (TCR), Routine Major	MON	Compliance Achieved	2/18/2011
BRICK CITY	187	BUCHANAN	IA3300770	TNC	201100145	Nitrate (as N)	30-Sep-10	Monitoring (Chem-Rad), Routine Major	MON	Compliance Achieved	2/18/2011
BRICK CITY	187	BUCHANAN	IA3300770	TNC	201107348	Coliform, Total (TCR)	31-Dec-10	Monitoring (TCR), Routine Major	MON	Compliance Achieved	2/18/2011
BRICK CITY	187	BUCHANAN	IA3300770	TNC	201107349	Nitrate (as N)	31-Dec-10	Monitoring (Chem-Rad), Routine Major	MON	Compliance Achieved	2/18/2011
BUBBLES	27	JACKSON	IA4934201	TNC	201006258	Fecal Coliform	31-Aug-10	MCL (TCR), Acute	MCL	Compliance Achieved	9/28/2010
BUBBLES	27	JACKSON	IA4934201	TNC	201006259	Coliform, Total (TCR)	31-Aug-10	MCL (TCR), Monthly	MCL	Compliance Achieved	9/28/2010
BUDES	75	DUBUQUE	IA3126211	TNC	201002137	Nitrate (as N)	30-Jun-10	Monitoring (Chem-Rad), Routine Major	MON	NOV Issued	7/20/2010
BUDES	75	DUBUQUE	IA3126211	TNC	201107405	Coliform, Total (TCR)	31-Dec-10	Monitoring (TCR), Routine Major	MON	Compliance Achieved	1/6/2011
BUFFALO CREEK - HICKORY HILL	25	LINN	IA5720975	TNC	201006771	Coliform, Total (TCR)	01-Aug-10	Monitoring (GWR), Source Major	MON	Compliance Achieved	9/9/2009
BURDS GREEN ACRES SUBDIVISION	385	DUBUQUE	IA3170302	CWS	201001049	Failure to meet Certified Operator Requirement	31-Jan-10	Certified Operator Requirement	STA	Compliance Achieved	5/1/2010
BURDS GREEN ACRES SUBDIVISION	385	DUBUQUE	IA3170302	CWS	201001439	Chlorine	31-Mar-10	Record Keeping	RPT	Compliance Achieved	4/26/2010
BURDS GREEN ACRES SUBDIVISION	385	DUBUQUE	IA3170302	CWS	201006346	Sodium	30-Jun-10	Monitoring (Chem-Rad), Routine Major	MON	Compliance Achieved	9/8/2010
CAFE IGUANAS INC	32	JOHNSON	IA5221206	TNC	201001296	Chlorine	31-Mar-10	Record Keeping	RPT	Compliance Achieved	10/12/2009
CALLENDER WATER SUPPLY	376	WEBSTER	IA9417063	CWS	201001315	Failure to use Treatment	31-Mar-10	Treatment Technique (Gross Alpha)	TT	NOV Issued	4/12/2010

Name of the Public Water Supply (Alphabetical Listing)	Minimum Population Served	County	PWSID	PWS Type	Violation Number	Analyte	Compliance End Date	Violation	Violation Type	Enforcement Action	Enforcement Action Date
CALLENDER WATER SUPPLY	376	WEBSTER	IA9417063	CWS	201107551	Gross Alpha, excluding Rn & U	31-Dec-10	Monitoring (Chem-Rad), Routine Major	MON	Compliance Achieved	3/14/2011
CALLENDER WATER SUPPLY	376	WEBSTER	IA9417063	CWS	201107552	Radium, Combined (226, 228)	31-Dec-10	Monitoring (Chem-Rad), Routine Major	MON	Compliance Achieved	3/8/2011
CAMP CONESTOGA	150	SCOTT	IA8264446	TNC	201002111	Nitrate (as N)	30-Jun-10	Monitoring (Chem-Rad), Routine Major	MON	Compliance Achieved	8/9/2010
CAMP CONESTOGA	150	SCOTT	IA8264446	TNC	201006219	Coliform, Total (TCR)	30-Sep-10	MCL (TCR), Monthly	MCL	Compliance Achieved	10/12/2010
CAMP CONESTOGA	150	SCOTT	IA8264446	TNC	201100069	Coliform, Total (TCR)	30-Sep-10	Monitoring (TCR), Routine Major	MON	Compliance Achieved	10/12/2010
CAMP COURAGEOUS OF IOWA	100	JONES	IA5343408	TNC	201001473	Nitrate (as N)	31-May-10	MCL (Chem-Rad), Single Sample	MCL	Compliance Achieved	10/5/2010
CAMP COURAGEOUS OF IOWA	100	JONES	IA5343408	TNC	201107136	Nitrate (as N)	31-Dec-10	MCL (Chem-Rad), Single Sample	MCL	Compliance Achieved	4/18/2011
CAMP INGAWANIS-MAPLE WELL	406	BREMER	IA0990401	TNC	201100118	Coliform, Total (TCR)	30-Sep-10	Monitoring (TCR), Routine Major	MON	Compliance Achieved	12/20/2010
CAMP INGAWANIS-RANGER WELL	150	BREMER	IA0990402	TNC	201100119	Coliform, Total (TCR)	30-Sep-10	Monitoring (TCR), Routine Major	MON	Compliance Achieved	12/20/2010
CAMP INGAWANIS-RANGER WELL	150	BREMER	IA0990402	TNC	201100120	Nitrate (as N)	30-Sep-10	Monitoring (Chem-Rad), Routine Major	MON	Compliance Achieved	12/20/2010
CAMP IODISECA	25	JOHNSON	IA5282802	TNC	201001451	Iowa Administrative Code	30-Apr-10	Monitoring (MOR)	MON	Compliance Achieved	2/10/2011
CAMP IODISECA	25	JOHNSON	IA5282802	TNC	201002259	Coliform, Total (TCR)	30-Sep-10	MCL (TCR), Monthly	MCL	Compliance Achieved	9/27/2010
CASCADE MUNICIPAL WATER SUPPLY	1958	DUBUQUE	IA3118080	CWS	201001093	Coliform, Total (TCR)	31-Jan-10	Monitoring (TCR), Routine Major	MON	Compliance Achieved	2/8/2010
CATTLEMENS STEAK & PROVISIONS	44	WRIGHT	IA9905786	TNC	201006324	Coliform, Total (TCR)	31-Jul-10	Monitoring (TCR), Repeat Major	MON	Compliance Achieved	8/24/2010
CATTLEMENS STEAK & PROVISIONS	44	WRIGHT	IA9905786	TNC	201006424	Coliform, Total (TCR)	29-Jul-10	Monitoring (GWR), Source Major	MON	Compliance Achieved	8/24/2010
CATTLEMENS STEAK & PROVISIONS	44	WRIGHT	IA9905786	TNC	201006485	Coliform, Total (TCR)	31-Aug-10	MCL (TCR), Monthly	MCL	Compliance Achieved	1/18/2011

Name of the Public Water Supply (Alphabetical Listing)	Minimum Population Served	County	PWSID	PWS Type	Violation Number	Analyte	Compliance End Date	Violation	Violation Type	Enforcement Action	Enforcement Action Date
CATTEMENS STEAK & PROVISIONS	44	WRIGHT	IA9905786	TNC	201100049	Coliform, Total (TCR)	30-Sep-10	Monitoring (TCR), Routine Major	MON	Compliance Achieved	11/9/2010
CATTEMENS STEAK & PROVISIONS	44	WRIGHT	IA9905786	TNC	201100059	Coliform, Total (TCR)	30-Sep-10	Monitoring (TCR), Repeat Major	MON	Compliance Achieved	11/9/2010
CATTEMENS STEAK & PROVISIONS	44	WRIGHT	IA9905786	TNC	201100287	Coliform, Total (TCR)	05-Sep-10	Monitoring (GWR), Source Major	MON	Compliance Achieved	11/9/2010
CEDAR LAKES INC	41	CEDAR	IA1689403	TNC	201002142	Nitrate (as N)	30-Jun-10	Monitoring (Chem-Rad), Routine Major	MON	Compliance Achieved	10/13/2010
CEDAR RAPIDS WATER DEPARTMENT	124488	LINN	IA5715093	CWS	201006872	Surface Water Treatment Rule (SWTR)	14-Sep-10	Treatment Technique (CT Ratio)	TT	Compliance Achieved	11/30/2010
CEDAR SPRINGS WESLEYAN CAMP	25	FLOYD	IA3414494	TNC	201001492	Coliform, Total (TCR)	23-Jan-10	Public Notice Rule Linked to Violation	PN	Compliance Achieved	5/24/2010
CEDAR VALLEY PRODUCE AUCTION	42	HOWARD	IA4525202	TNC	201107412	Coliform, Total (TCR)	31-Dec-10	Monitoring (TCR), Routine Major	MON	Compliance Achieved	3/21/2011
CENTER JUNCTION WATER DEPT	111	JONES	IA5315005	CWS	201100329	Coliform, Total (TCR)	31-Oct-10	MCL (TCR), Monthly	MCL	Compliance Achieved	12/21/2010
CENTER JUNCTION WATER DEPT	111	JONES	IA5315005	CWS	201107521	Arsenic	31-Dec-10	Monitoring (Chem-Rad), Routine Major	MON	Compliance Achieved	3/1/2011
CENTRAL IA WATER ASSN (WAVERLY)	31605	BREMER	IA0990701	CWS	201006204	Lead	30-Jun-10	AL (Pb/Cu), 90th Percentile	MCL	NOV Issued	8/11/2010
CENTRAL WATER WORKS	27	WEBSTER	IA9400801	CWS	201001592	Sodium	31-Mar-10	Monitoring (Chem-Rad), Routine Major	MON	Compliance Achieved	6/8/2010
CHURCH OF JESUS CHRIST OF LDS (ATLANTIC)	197	CASS	IA1509801	TNC	201107419	Nitrate (as N)	31-Dec-10	Monitoring (Chem-Rad), Routine Major	MON	Compliance Achieved	2/16/2011
CHURDAN WATER SUPPLY	418	GREENE	IA3709001	CWS	201001018	Nitrite (as N)	31-Jan-10	MCL (Chem-Rad), Single Sample	MCL	BCA Signed	9/27/2010
CHURDAN WATER SUPPLY	418	GREENE	IA3709001	CWS	201001153	Nitrite (as N)	28-Feb-10	MCL (Chem-Rad), Single Sample	MCL	BCA Signed	9/27/2010
CHURDAN WATER SUPPLY	418	GREENE	IA3709001	CWS	201001154	Nitrite (as N)	28-Feb-10	MCL (Chem-Rad), Single Sample	MCL	BCA Signed	9/27/2010
CHURDAN WATER SUPPLY	418	GREENE	IA3709001	CWS	201001275	Nitrite (as N)	31-Mar-10	MCL (Chem-Rad), Single Sample	MCL	BCA Signed	9/27/2010

Name of the Public Water Supply (Alphabetical Listing)	Minimum Population Served	County	PWSID	PWS Type	Violation Number	Analyte	Compliance End Date	Violation	Violation Type	Enforcement Action	Enforcement Action Date
CHURDAN WATER SUPPLY	418	GREENE	IA3709001	CWS	201001276	Nitrite (as N)	31-Mar-10	MCL (Chem-Rad), Single Sample	MCL	BCA Signed	9/27/2010
CHURDAN WATER SUPPLY	418	GREENE	IA3709001	CWS	201001486	Nitrite (as N)	31-May-10	MCL (Chem-Rad), Single Sample	MCL	BCA Signed	9/27/2010
CHURDAN WATER SUPPLY	418	GREENE	IA3709001	CWS	201001487	Nitrite (as N)	31-May-10	MCL (Chem-Rad), Single Sample	MCL	BCA Signed	9/27/2010
CHURDAN WATER SUPPLY	418	GREENE	IA3709001	CWS	201001810	Nitrite (as N)	30-Jun-10	MCL (Chem-Rad), Single Sample	MCL	BCA Signed	9/27/2010
CHURDAN WATER SUPPLY	418	GREENE	IA3709001	CWS	201001811	Nitrite (as N)	30-Jun-10	MCL (Chem-Rad), Single Sample	MCL	BCA Signed	9/27/2010
CHURDAN WATER SUPPLY	418	GREENE	IA3709001	CWS	201002003	Nitrite (as N)	31-Jul-10	MCL (Chem-Rad), Single Sample	MCL	BCA Signed	9/27/2010
CHURDAN WATER SUPPLY	418	GREENE	IA3709001	CWS	201006445	Nitrite (as N)	31-Aug-10	MCL (Chem-Rad), Single Sample	MCL	BCA Signed	9/27/2010
CHURDAN WATER SUPPLY	418	GREENE	IA3709001	CWS	201006446	Nitrite (as N)	31-Aug-10	MCL (Chem-Rad), Single Sample	MCL	BCA Signed	9/27/2010
CHURDAN WATER SUPPLY	418	GREENE	IA3709001	CWS	201006627	Nitrite (as N)	30-Sep-10	MCL (Chem-Rad), Single Sample	MCL	BCA Signed	9/27/2010
CHURDAN WATER SUPPLY	418	GREENE	IA3709001	CWS	201100304	Nitrite (as N)	31-Oct-10	MCL (Chem-Rad), Single Sample	MCL	BCA Signed	9/27/2010
CHURDAN WATER SUPPLY	418	GREENE	IA3709001	CWS	201107097	Nitrite (as N)	30-Nov-10	MCL (Chem-Rad), Single Sample	MCL	BCA Signed	9/27/2010
CHURDAN WATER SUPPLY	418	GREENE	IA3709001	CWS	201107263	Nitrite (as N)	31-Dec-10	MCL (Chem-Rad), Single Sample	MCL	BCA Signed	9/27/2010
CIWA (DOWS)	2042	FRANKLIN	IA3564901	NTNC	201107453	Lead	31-Dec-10	AL (Pb/Cu), 90th Percentile	MCL	NOV Issued	1/31/2011
CLARINDA TREATMENT COMPLEX	1439	PAGE	IA7329501	CWS	201100311	Copper	30-Sep-10	AL (Pb/Cu), 90th Percentile	MCL	NOV Issued	10/21/2010
CLARINDA WATER PLANT	4822	PAGE	IA7329029	CWS	201107654	Turbidity	31-Oct-10	Record Keeping	RPT	NOV Issued	3/14/2011
CLARMOND COUNTRY CLUB	40	WRIGHT	IA9905872	TNC	201001716	Coliform, Total (TCR)	31-May-10	Monitoring (TCR), Repeat Major	MON	Compliance Achieved	6/3/2010

Name of the Public Water Supply (Alphabetical Listing)	Minimum Population Served	County	PWSID	PWS Type	Violation Number	Analyte	Compliance End Date	Violation	Violation Type	Enforcement Action	Enforcement Action Date
CLARMOND COUNTRY CLUB	40	WRIGHT	IA9905872	TNC	201001777	Coliform, Total (TCR)	24-May-10	Monitoring (GWR), Source Major	MON	Compliance Achieved	6/3/2010
CLAYTON WATER SUPPLY	55	CLAYTON	IA2203039	CWS	201006523	Failure to Issue Consumer Confidence Report	31-Jul-10	Consumer Confidence Report (CCR)	RPT	Compliance Achieved	9/7/2010
CLEAR CREEK MHP	150	JOHNSON	IA5288601	CWS	201006513	Failure to Issue Consumer Confidence Report	31-Jul-10	Consumer Confidence Report (CCR)	RPT	Referred for AO	4/8/2011
CLEAR CREEK MHP	150	JOHNSON	IA5288601	CWS	201107050	Copper	30-Sep-10	Routine/Repeat Tap Sampling (Pb/Cu)	MON	Referred for AO	4/8/2011
CLEAR CREEK MHP	150	JOHNSON	IA5288601	CWS	201107051	Lead	30-Sep-10	Routine/Repeat Tap Sampling (Pb/Cu)	MON	Referred for AO	4/8/2011
CLEAR CREEK MHP	150	JOHNSON	IA5288601	CWS	201107427	Failure to meet Certified Operator Requirement	26-Mar-10	Certified Operator Requirement	STA	Referred for AO	4/8/2011
CLEAR CREEK MHP	150	JOHNSON	IA5288601	CWS	201107428	Failure to meet Certified Operator Requirement	27-Aug-10	Certified Operator Requirement	STA	Referred for AO	4/8/2011
CLEAR CREEK MHP	150	JOHNSON	IA5288601	CWS	201107429	Failure to meet Certified Operator Requirement	19-Nov-10	Certified Operator Requirement	STA	Referred for AO	4/8/2011
CLEAR CREEK MHP	150	JOHNSON	IA5288601	CWS	201107463	Chlorine	31-Dec-10	Monitoring (DBP), Major	MON	Referred for AO	4/8/2011
CLEAR CREEK MHP	150	JOHNSON	IA5288601	CWS	201107748	Failure to meet Certified Operator Requirement	07-Jun-10	Certified Operator Requirement	STA	Referred for AO	4/8/2011
CLERMONT WATER SUPPLY	632	FAYETTE	IA3317047	CWS	201001531	Gross Alpha, excluding Rn & U	31-Mar-10	Monitoring (Chem-Rad), Routine Major	MON	Compliance Achieved	6/9/2010
CLERMONT WATER SUPPLY	632	FAYETTE	IA3317047	CWS	201006875	Failure to meet Certified Operator Requirement	31-Oct-10	Certified Operator Requirement	STA	Compliance Achieved	12/10/2010
CLIFFS PLACE INC	51	BREMER	IA0929200	TNC	201001075	Nitrate (as N)	31-Jan-10	Monitoring (Chem-Rad), Routine Major	MON	Compliance Achieved	2/10/2010
CLIFFS PLACE INC	51	BREMER	IA0929200	TNC	201001076	Coliform, Total (TCR)	31-Jan-10	Monitoring (TCR), Routine Major	MON	Compliance Achieved	2/10/2010
CLIFFS PLACE INC	51	BREMER	IA0929200	TNC	201001819	Coliform, Total (TCR)	30-Jun-10	MCL (TCR), Monthly	MCL	Compliance Achieved	2/16/2011
CLIFFS PLACE INC	51	BREMER	IA0929200	TNC	201006333	Nitrate (as N)	31-Jul-10	Monitoring (Chem-Rad), Routine Major	MON	Compliance Achieved	2/16/2011

Name of the Public Water Supply (Alphabetical Listing)	Minimum Population Served	County	PWSID	PWS Type	Violation Number	Analyte	Compliance End Date	Violation	Violation Type	Enforcement Action	Enforcement Action Date
CLIFFS PLACE INC	51	BREMER	IA0929200	TNC	201006721	Nitrate (as N)	31-Aug-10	Monitoring (Chem-Rad), Routine Major	MON	Compliance Achieved	2/16/2011
CLIFFS PLACE INC	51	BREMER	IA0929200	TNC	201100114	Nitrate (as N)	30-Sep-10	Monitoring (Chem-Rad), Routine Major	MON	Compliance Achieved	2/16/2011
CLIFFS PLACE INC	51	BREMER	IA0929200	TNC	201100115	Coliform, Total (TCR)	30-Sep-10	Monitoring (TCR), Routine Major	MON	Compliance Achieved	12/16/2010
CLIFFS PLACE INC	51	BREMER	IA0929200	TNC	201106955	Coliform, Total (TCR)	31-Oct-10	Monitoring (TCR), Routine Major	MON	Compliance Achieved	12/16/2010
CLIFFS PLACE INC	51	BREMER	IA0929200	TNC	201106956	Nitrate (as N)	31-Oct-10	Monitoring (Chem-Rad), Routine Major	MON	Compliance Achieved	2/16/2011
CLIFFS PLACE INC	51	BREMER	IA0929200	TNC	201107191	Coliform, Total (TCR)	30-Nov-10	Monitoring (TCR), Routine Major	MON	Compliance Achieved	12/16/2010
CLIFFS PLACE INC	51	BREMER	IA0929200	TNC	201107192	Nitrate (as N)	30-Nov-10	Monitoring (Chem-Rad), Routine Major	MON	Compliance Achieved	2/16/2011
CLIFFS PLACE INC	51	BREMER	IA0929200	TNC	201107325	Nitrate (as N)	31-Dec-10	Monitoring (Chem-Rad), Routine Major	MON	Compliance Achieved	2/16/2011
CLINTON COUNTRY CLUB AT THE OAKS	100	CLINTON	IA2326848	TNC	201002064	Nitrate (as N)	30-Jun-10	Monitoring (Chem-Rad), Routine Major	MON	Compliance Achieved	9/28/2010
CLINTON COUNTRY CLUB AT THE OAKS	100	CLINTON	IA2326848	TNC	201002065	Coliform, Total (TCR)	30-Jun-10	Monitoring (TCR), Routine Major	MON	Compliance Achieved	9/28/2010
CLUB SHAKERS	136	JACKSON	IA4945202	TNC	201001345	Coliform, Total (TCR)	30-Apr-10	Monitoring (TCR), Repeat Major	MON	Compliance Achieved	6/14/2010
CLUB SHAKERS	136	JACKSON	IA4945202	TNC	201001420	Coliform, Total (TCR)	17-Apr-10	Monitoring (GWR), Source Major	MON	Compliance Achieved	1/1/2011
CLUB SHAKERS	136	JACKSON	IA4945202	TNC	201100294	Coliform, Total (TCR)	26-Sep-10	Monitoring (GWR), Source Major	MON	Compliance Achieved	1/1/2011
COAL VALLEY WATER DISTRICT	180	BOONE	IA0819303	CWS	201006205	Coliform, Total (TCR)	31-Aug-10	MCL (TCR), Monthly	MCL	Compliance Achieved	9/22/2010
COLLEGE COMMUNITY SCHOOL DISTRICT	45	LINN	IA5715501	TNC	201001766	Coliform, Total (TCR)	31-May-10	Monitoring (TCR), Routine Major	MON	Compliance Achieved	6/24/2010
COLLEGE COMMUNITY SCHOOL DISTRICT	45	LINN	IA5715501	TNC	201002128	Nitrate (as N)	30-Jun-10	Monitoring (Chem-Rad), Routine Major	MON	NOV Issued	7/20/2010

Name of the Public Water Supply (Alphabetical Listing)	Minimum Population Served	County	PWSID	PWS Type	Violation Number	Analyte	Compliance End Date	Violation	Violation Type	Enforcement Action	Enforcement Action Date
COMMUNITY COUNTRY STORE	91	JOHNSON	IA5221207	TNC	201107417	Coliform, Total (TCR)	31-Dec-10	Monitoring (TCR), Routine Major	MON	Compliance Achieved	1/5/2011
COMMUNITY ORCHARD	154	WEBSTER	IA9433203	TNC	201006575	Coliform, Total (TCR)	30-Sep-10	MCL (TCR), Monthly	MCL	Compliance Achieved	10/14/2010
CONSUMERS COOPERATIVE SOCIETY	40	JOHNSON	IA5225208	TNC	201100238	Coliform, Total (TCR)	30-Sep-10	Monitoring (TCR), Routine Major	MON	Compliance Achieved	10/5/2010
COONHUNTERS	52	JONES	IA5377201	TNC	201001801	Fecal Coliform	30-Jun-10	MCL (TCR), Acute	MCL	Compliance Achieved	1/31/2011
COONHUNTERS	52	JONES	IA5377201	TNC	201001802	Coliform, Total (TCR)	30-Jun-10	MCL (TCR), Monthly	MCL	Compliance Achieved	1/31/2011
CORALVILLE LAKE TERRACE	340	JOHNSON	IA5200817	CWS	201001717	Coliform, Total (TCR)	31-May-10	Monitoring (TCR), Repeat Major	MON	Compliance Achieved	5/11/2010
CORALVILLE LAKE TERRACE	340	JOHNSON	IA5200817	CWS	201001731	Coliform, Total (TCR)	31-May-10	Monitoring (TCR), Repeat Major	MON	Compliance Achieved	5/12/2010
CORALVILLE LAKE TERRACE	340	JOHNSON	IA5200817	CWS	201001787	Coliform, Total (TCR)	01-May-10	Monitoring (GWR), Source Major	MON	Compliance Achieved	5/11/2010
CORALVILLE LAKE TERRACE	340	JOHNSON	IA5200817	CWS	201006546	Failure to Issue Consumer Confidence Report	01-Jul-10	Consumer Confidence Report (CCR)	RPT	NOV Issued	9/2/2010
CORALVILLE LAKE TERRACE	340	JOHNSON	IA5200817	CWS	201006547	Failure to Issue Consumer Confidence Report	01-Jul-10	Consumer Confidence Report (CCR)	RPT	NOV Issued	9/2/2010
CORALVILLE LAKE TERRACE	340	JOHNSON	IA5200817	CWS	201006610	Groundwater Rule	30-Sep-10	Failure Address Deficiency (GWR)	TT	Compliance Achieved	4/13/2011
CORALVILLE LAKE TERRACE	340	JOHNSON	IA5200817	CWS	201106993	Copper	30-Sep-10	Routine/Repeat Tap Sampling (Pb/Cu)	MON	BCA Signed	11/30/2010
CORALVILLE LAKE TERRACE	340	JOHNSON	IA5200817	CWS	201106994	Lead	30-Sep-10	Routine/Repeat Tap Sampling (Pb/Cu)	MON	BCA Signed	11/30/2010
CORALVILLE LAKE TERRACE	340	JOHNSON	IA5200817	CWS	201106995	Copper	30-Sep-10	Routine/Repeat Tap Sampling (Pb/Cu)	MON	BCA Signed	11/30/2010
CORALVILLE LAKE TERRACE	340	JOHNSON	IA5200817	CWS	201106996	Lead	30-Sep-10	Routine/Repeat Tap Sampling (Pb/Cu)	MON	BCA Signed	11/30/2010
CORALVILLE LAKE TERRACE	340	JOHNSON	IA5200817	CWS	201107112	Groundwater Rule	26-May-10	Failure Address Deficiency (GWR)	TT	Compliance Achieved	4/13/2011

Name of the Public Water Supply (Alphabetical Listing)	Minimum Population Served	County	PWSID	PWS Type	Violation Number	Analyte	Compliance End Date	Violation	Violation Type	Enforcement Action	Enforcement Action Date
CORALVILLE LAKE TERRACE	340	JOHNSON	IA5200817	CWS	201107362	Nitrate (as N)	31-Dec-10	Monitoring (Chem-Rad), Routine Major	MON	NOV Issued	1/19/2011
CORALVILLE LAKE TERRACE	340	JOHNSON	IA5200817	CWS	201107363	Nitrate (as N)	31-Dec-10	Monitoring (Chem-Rad), Routine Major	MON	NOV Issued	1/19/2011
CORALVILLE LAKE TERRACE	340	JOHNSON	IA5200817	CWS	201107642	Failure to meet Certified Operator Requirement	31-Dec-10	Certified Operator Requirement	STA	Compliance Achieved	4/13/2011
CORALVILLE LAKE TERRACE	340	JOHNSON	IA5200817	CWS	201107644	Disinfection Byproducts Rule	31-Dec-10	Failure to have Monitoring Plan (DBP)	MON	Compliance Achieved	4/13/2011
CORALVILLE LAKE-AD BLDG	295	JOHNSON	IA5225413	TNC	201002280	Coliform, Total (TCR)	30-Sep-10	MCL (TCR), Monthly	MCL	Compliance Achieved	10/6/2010
CORALVILLE LAKE-AD BLDG	295	JOHNSON	IA5225413	TNC	201006589	Coliform, Total (TCR)	30-Sep-10	MCL (TCR), Monthly	MCL	Compliance Achieved	10/6/2010
CORALVILLE LAKE-WEST OVERLOOK	1263	JOHNSON	IA5225411	TNC	201006741	Coliform, Total (TCR)	31-Aug-10	Monitoring (TCR), Routine Major	MON	Compliance Achieved	9/1/2010
CORNER MARKET	32	SCOTT	IA8258201	TNC	201100255	Nitrate (as N)	30-Sep-10	Monitoring (Chem-Rad), Routine Major	MON	Compliance Achieved	10/20/2010
CORPORATION OF NEW MELLERAY	108	DUBUQUE	IA3100899	CWS	201001331	Iowa Administrative Code	31-Mar-10	Monitoring (MOR)	MON	NOV Issued	4/14/2010
CORPORATION OF NEW MELLERAY	108	DUBUQUE	IA3100899	CWS	201001334	Chlorine	31-Mar-10	Record Keeping	RPT	Compliance Achieved	10/7/2010
CORPORATION OF NEW MELLERAY	108	DUBUQUE	IA3100899	CWS	201001335	Iowa Administrative Code	28-Feb-10	Monitoring (MOR)	MON	NOV Issued	4/14/2010
CORPORATION OF NEW MELLERAY	108	DUBUQUE	IA3100899	CWS	201002070	Coliform, Total (TCR)	30-Jun-10	Monitoring (TCR), Routine Major	MON	Compliance Achieved	7/28/2010
CORPORATION OF NEW MELLERAY	108	DUBUQUE	IA3100899	CWS	201006213	Chlorine Residual, Free	30-Jun-10	Record Keeping	RPT	Compliance Achieved	10/7/2010
CORPORATION OF NEW MELLERAY	108	DUBUQUE	IA3100899	CWS	201006524	Failure to Issue Consumer Confidence Report	31-Jul-10	Consumer Confidence Report (CCR)	RPT	NOV Issued	8/31/2010
COULTER WATER SUPPLY	281	FRANKLIN	IA3525079	CWS	201100148	Total Trihalomethanes (TTHM)	31-Aug-10	Monitoring (Chem-Rad), Routine Major	MON	BCA Signed	10/28/2010
COULTER WATER SUPPLY	281	FRANKLIN	IA3525079	CWS	201100149	Total Haloacetic Acids (HAA5)	31-Aug-10	Monitoring (DBP), Major	MON	BCA Signed	10/28/2010

Name of the Public Water Supply (Alphabetical Listing)	Minimum Population Served	County	PWSID	PWS Type	Violation Number	Analyte	Compliance End Date	Violation	Violation Type	Enforcement Action	Enforcement Action Date
COUNTRY HILLS WATER CORP	38	DUBUQUE	IA3122301	CWS	201001936	Coliform, Total (TCR)	31-Jul-10	MCL (TCR), Monthly	MCL	Compliance Achieved	9/13/2010
COUNTRY HILLS WATER CORP	38	DUBUQUE	IA3122301	CWS	201006447	Coliform, Total (TCR)	31-Aug-10	MCL (TCR), Monthly	MCL	Compliance Achieved	9/13/2010
COUNTRY MANOR ESTATES	228	LINN	IA5784307	CWS	201001897	Coliform, Total (TCR)	31-Jul-10	MCL (TCR), Monthly	MCL	Compliance Achieved	12/20/2010
COUNTRY MANOR ESTATES	228	LINN	IA5784307	CWS	201100176	Nitrate (as N)	30-Sep-10	Monitoring (Chem-Rad), Routine Major	MON	Compliance Achieved	8/31/2010
COUNTRY MANOR ESTATES	228	LINN	IA5784307	CWS	201107533	Radium, Combined (226, 228)	31-Dec-10	Monitoring (Chem-Rad), Routine Major	MON	NOV Issued	2/25/2011
CRESCENT WATER SUPPLY	687	POTTAWATTAMIE	IA7822086	CWS	201006218	Coliform, Total (TCR)	31-Aug-10	MCL (TCR), Monthly	MCL	Compliance Achieved	9/7/2010
CRESTVIEW MOBILE HOME PARK	95	STORY	IA8500605	CWS	201001465	Chlorine Residual, Free	04-May-10	Record Keeping	RPT	NOV Issued	5/4/2010
CRESTVIEW MOBILE HOME PARK	95	STORY	IA8500605	CWS	201001591	Benzo (a) Pyrene	31-Mar-10	Monitoring (Chem-Rad), Routine Major	MON	Compliance Achieved	6/22/2010
CRESTVIEW MOBILE HOME PARK	95	STORY	IA8500605	CWS	201006388	Sodium	30-Jun-10	Monitoring (Chem-Rad), Routine Major	MON	Compliance Achieved	9/27/2010
CRESTVIEW MOBILE HOME PARK	95	STORY	IA8500605	CWS	201006439	Failure to Provide Public Notice	04-Aug-10	Public Notice Rule Linked to Violation	PN	Compliance Achieved	11/10/2010
CTR FOR ALCOHOL/DRUG SERV (COUNTRY OAKS)	80	SCOTT	IA8222451	TNC	201107295	Iowa Administrative Code	31-Dec-10	Monitoring (MOR)	MON	Compliance Achieved	3/7/2011
DANBURY WATER SUPPLY	391	WOODBURY	IA9729099	CWS	201100206	Total Haloacetic Acids (HAA5)	31-Aug-10	Monitoring (DBP), Major	MON	BCA Signed	10/26/2010
DANBURY WATER SUPPLY	391	WOODBURY	IA9729099	CWS	201100207	Total Trihalomethanes (TTHM)	31-Aug-10	Monitoring (Chem-Rad), Routine Major	MON	BCA Signed	10/26/2010
DECORAH IMPLEMENT COMPANY	50	WINNESHIEK	IA9630768	TNC	201001393	Nitrate (as N)	31-Mar-10	Monitoring (Chem-Rad), Routine Major	MON	Compliance Achieved	5/5/2010
DEER RIDGE HOMEOWNERS WATER ASSC.	94	LINN	IA5765303	CWS	201001643	Coliform, Total (TCR)	30-Jun-10	MCL (TCR), Monthly	MCL	Compliance Achieved	12/2/2010
DEER VALLEY HOMEOWNERS ASSOC	46	SCOTT	IA8215325	CWS	201001033	Coliform, Total (TCR)	31-Jan-10	MCL (TCR), Monthly	MCL	Compliance Achieved	1/3/2011

Name of the Public Water Supply (Alphabetical Listing)	Minimum Population Served	County	PWSID	PWS Type	Violation Number	Analyte	Compliance End Date	Violation	Violation Type	Enforcement Action	Enforcement Action Date
DEER VALLEY HOMEOWNERS ASSOC	46	SCOTT	IA8215325	CWS	201001761	Coliform, Total (TCR)	31-May-10	Monitoring (TCR), Routine Major	MON	Compliance Achieved	6/17/2010
DEER VALLEY LODGE	100	CERRO GORDO	IA1785421	TNC	201006278	Coliform, Total (TCR)	31-Jul-10	Monitoring (TCR), Routine Major	MON	Compliance Achieved	8/30/2010
DEER VALLEY LODGE	100	CERRO GORDO	IA1785421	TNC	201006317	Coliform, Total (TCR)	31-Jul-10	Monitoring (TCR), Routine Major	MON	Compliance Achieved	8/30/2010
DEER VALLEY LODGE	100	CERRO GORDO	IA1785421	TNC	201006516	Coliform, Total (TCR)	30-Sep-10	MCL (TCR), Monthly	MCL	Compliance Achieved	9/22/2010
DEER VALLEY LODGE	100	CERRO GORDO	IA1785421	TNC	201100122	Nitrate (as N)	30-Sep-10	Monitoring (Chem-Rad), Routine Major	MON	Compliance Achieved	12/17/2010
DEERWOOD GOLF INC	306	HENRY	IA4458201	TNC	201100234	Coliform, Total (TCR)	30-Sep-10	Monitoring (TCR), Routine Major	MON	Compliance Achieved	3/10/2011
DEERWOOD GOLF INC	306	HENRY	IA4458201	TNC	201107407	Coliform, Total (TCR)	31-Dec-10	Monitoring (TCR), Routine Major	MON	Compliance Achieved	3/11/2011
DEESE THIRSTY CAMEL	67	LOUISA	IA7016202	TNC	201100223	Coliform, Total (TCR)	30-Sep-10	Monitoring (TCR), Routine Major	MON	Compliance Achieved	1/28/2011
DEESE THIRSTY CAMEL	67	LOUISA	IA7016202	TNC	201100224	Nitrate (as N)	30-Sep-10	Monitoring (Chem-Rad), Routine Major	MON	Compliance Achieved	1/28/2011
DEESE THIRSTY CAMEL	67	LOUISA	IA7016202	TNC	201107033	Nitrate (as N)	31-Oct-10	Monitoring (Chem-Rad), Routine Major	MON	Compliance Achieved	1/28/2011
DEESE THIRSTY CAMEL	67	LOUISA	IA7016202	TNC	201107398	Nitrate (as N)	31-Dec-10	Monitoring (Chem-Rad), Routine Major	MON	Compliance Achieved	1/28/2011
DELHI LAKEVIEW ESTATES	35	DELAWARE	IA2817456	TNC	201001521	Coliform, Total (TCR)	30-Apr-10	Monitoring (TCR), Routine Major	MON	Compliance Achieved	5/10/2010
DELHI LAKEVIEW ESTATES	35	DELAWARE	IA2817456	TNC	201006341	Coliform, Total (TCR)	31-Jul-10	Monitoring (TCR), Routine Major	MON	Compliance Achieved	8/25/2010
DELHI LAKEVIEW ESTATES	35	DELAWARE	IA2817456	TNC	201106970	Coliform, Total (TCR)	31-Oct-10	Monitoring (TCR), Routine Major	MON	Compliance Achieved	11/10/2010
DENVER HILLS SUBDIVISION	50	BREMER	IA0915301	CWS	201006525	Failure to Issue Consumer Confidence Report	01-Jul-10	Consumer Confidence Report (CCR)	RPT	Compliance Achieved	9/3/2010
DENVER WATER SUPPLY	1627	BREMER	IA0915030	CWS	201001516	Radium, Combined (226, 228)	31-Mar-10	Monitoring (Chem-Rad), Routine Major	MON	Compliance Achieved	6/20/2010

Name of the Public Water Supply (Alphabetical Listing)	Minimum Population Served	County	PWSID	PWS Type	Violation Number	Analyte	Compliance End Date	Violation	Violation Type	Enforcement Action	Enforcement Action Date
DEXTER WATER SUPPLY	689	DALLAS	IA2533038	CWS	201001520	Di(2-Ethylhexyl) Phthalate	31-Mar-10	Monitoring (Chem-Rad), Routine Major	MON	Compliance Achieved	6/9/2010
DIAGONAL WATER DEPARTMENT	330	RINGGOLD	IA8018040	CWS	201001614	Coliform, Total (TCR)	31-May-10	MCL (TCR), Monthly	MCL	Compliance Achieved	11/29/2010
DIXON MEMORIAL PARK	30	SCOTT	IA8225495	TNC	201100192	Coliform, Total (TCR)	30-Sep-10	Monitoring (TCR), Routine Major	MON	NOV Issued	10/19/2010
DIXON WATER WORKS	247	SCOTT	IA8225043	CWS	201006579	Nitrate (as N)	30-Sep-10	MCL (Chem-Rad), Single Sample	MCL	Compliance Achieved	3/1/2011
DIXON WATER WORKS	247	SCOTT	IA8225043	CWS	201107121	Nitrate (as N)	31-Dec-10	MCL (Chem-Rad), Single Sample	MCL	Compliance Achieved	3/1/2011
DOON WATER SUPPLY	533	LYON	IA6015047	CWS	201001548	Coliform, Total (TCR)	30-Apr-10	Monitoring (TCR), Routine Major	MON	Compliance Achieved	5/4/2010
DOON WATER SUPPLY	533	LYON	IA6015047	CWS	201001618	Chlorine	30-Jun-10	Monitoring (DBP), Major	MON	Compliance Achieved	9/8/2010
DUBUQUE REGIONAL AIRPORT	420	DUBUQUE	IA3126013	NTNC	201001050	Failure to meet Certified Operator Requirement	31-Jan-10	Certified Operator Requirement	STA	Compliance Achieved	10/6/2010
DUBUQUE SPORTS COMPLEX	400	DUBUQUE	IA3126208	TNC	201107399	Coliform, Total (TCR)	31-Dec-10	Monitoring (TCR), Routine Major	MON	Compliance Achieved	1/4/2011
DUNKERTON MUNI WATER SUPPLY	750	BLACK HAWK	IA0717084	CWS	201001639	Failure to Obtain a Construction Permit	31-May-10	Construction Without Permit	STA	Compliance Achieved	5/17/2010
DUNLAP WATER SUPPLY	1139	HARRISON	IA4316087	CWS	201006442	Iowa Administrative Code	30-Jun-10	Monitoring (MOR)	MON	Compliance Achieved	9/30/2010
DYERSVILLE GOLF AND COUNTRY CLUB	40	DUBUQUE	IA3130883	TNC	201001626	Nitrate (as N)	31-May-10	MCL (Chem-Rad), Single Sample	MCL	Compliance Achieved	11/29/2010
DYSART WATER SUPPLY	1303	TAMA	IA8627095	CWS	201001121	Coliform, Total (TCR)	31-Jan-10	Monitoring (TCR), Routine Major	MON	Compliance Achieved	2/2/2010
EAGLE LANE CORPORATION	53	SCOTT	IA8215308	CWS	201001836	Coliform, Total (TCR)	30-Jun-10	MCL (TCR), Monthly	MCL	Compliance Achieved	2/14/2011
EARLING WATER SUPPLY	471	SHELBY	IA8320098	CWS	201100194	Coliform, Total (TCR)	30-Sep-10	Monitoring (TCR), Routine Major	MON	Compliance Achieved	10/12/2010
EARLY MUNICIPAL WATER SUPPLY	675	SAC	IA8114000	CWS	201107229	Nitrate (as N)	30-Nov-10	Monitoring (Chem-Rad), Routine Major	MON	Compliance Achieved	12/1/2010

Name of the Public Water Supply (Alphabetical Listing)	Minimum Population Served	County	PWSID	PWS Type	Violation Number	Analyte	Compliance End Date	Violation	Violation Type	Enforcement Action	Enforcement Action Date
EASTERN HILLS BAPTIST CHURCH	101	POTTAWATTAMIE	IA7820851	NTNC	201001118	Coliform, Total (TCR)	31-Jan-10	Monitoring (TCR), Routine Major	MON	Compliance Achieved	2/24/2010
EASTERN HILLS BAPTIST CHURCH	101	POTTAWATTAMIE	IA7820851	NTNC	201001386	Nitrate (as N)	31-Mar-10	Monitoring (Chem-Rad), Routine Major	MON	Compliance Achieved	4/29/2010
EDGEWATER GOLF COURSE	41	FAYETTE	IA3300769	TNC	201001892	Coliform, Total (TCR)	30-Jun-10	MCL (TCR), Monthly	MCL	Compliance Achieved	9/23/2010
EDGEWATER GOLF COURSE	41	FAYETTE	IA3300769	TNC	201001954	Fecal Coliform	30-Jun-10	MCL (TCR), Acute	MCL	Compliance Achieved	9/23/2010
EDGEWATER GOLF COURSE	41	FAYETTE	IA3300769	TNC	201006351	Nitrate (as N)	31-Jul-10	Monitoring (Chem-Rad), Routine Major	MON	Compliance Achieved	8/12/2010
EDGEWATER GOLF COURSE	41	FAYETTE	IA3300769	TNC	201107149	Coliform, Total (TCR)	30-Nov-10	Monitoring (TCR), Repeat Major	MON	NOV Issued	12/15/2010
EDGEWATER GOLF COURSE	41	FAYETTE	IA3300769	TNC	201107242	Coliform, Total (TCR)	11-Nov-10	Monitoring (GWR), Source Major	MON	NOV Issued	12/15/2010
EIP MANUFACTURING, LLC	60	DELAWARE	IA2825101	NTNC	201001025	Failure to meet Certified Operator Requirement	31-Jan-10	Certified Operator Requirement	STA	Compliance Achieved	2/1/2010
EIP MANUFACTURING, LLC	60	DELAWARE	IA2825101	NTNC	201006392	Nitrate (as N)	31-Jul-10	Monitoring (Chem-Rad), Routine Major	MON	Compliance Achieved	8/31/2010
ELBERON WATER SUPPLY	245	TAMA	IA8631003	CWS	201006390	Coliform, Total (TCR)	31-Jul-10	Monitoring (TCR), Routine Major	MON	Compliance Achieved	8/9/2010
ELBERON WATER SUPPLY	245	TAMA	IA8631003	CWS	201006436	Chlorine	30-Sep-10	Monitoring (DBP), Major	MON	Compliance Achieved	8/9/2010
ELBERON WATER SUPPLY	245	TAMA	IA8631003	CWS	201107021	Coliform, Total (TCR)	31-Oct-10	Monitoring (TCR), Routine Major	MON	Compliance Achieved	11/2/2010
ELBERON WATER SUPPLY	245	TAMA	IA8631003	CWS	201107086	Chlorine	31-Oct-10	Monitoring (DBP), Major	MON	Compliance Achieved	11/2/2010
ELDON C STUTSMAN INC	165	JOHNSON	IA5221101	NTNC	201001152	Nitrate (as N)	31-Mar-10	MCL (Chem-Rad), Single Sample	MCL	BCA Signed	2/25/2011
ELDON C STUTSMAN INC	165	JOHNSON	IA5221101	NTNC	201001428	Nitrate (as N)	30-Apr-10	MCL (Chem-Rad), Single Sample	MCL	BCA Signed	2/25/2011
ELDON C STUTSMAN INC	165	JOHNSON	IA5221101	NTNC	201001674	Nitrate (as N)	30-Jun-10	MCL (Chem-Rad), Single Sample	MCL	BCA Signed	2/25/2011

Name of the Public Water Supply (Alphabetical Listing)	Minimum Population Served	County	PWSID	PWS Type	Violation Number	Analyte	Compliance End Date	Violation	Violation Type	Enforcement Action	Enforcement Action Date
ELDON C STUTSMAN INC	165	JOHNSON	IA5221101	NTNC	201001773	Nitrate (as N)	31-May-10	Monitoring (Chem-Rad), Routine Major	MON	Compliance Achieved	6/10/2010
ELDON C STUTSMAN INC	165	JOHNSON	IA5221101	NTNC	201002244	Nitrate (as N)	31-Jul-10	MCL (Chem-Rad), Single Sample	MCL	BCA Signed	2/25/2011
ELDON C STUTSMAN INC	165	JOHNSON	IA5221101	NTNC	201006228	Nitrate (as N)	31-Aug-10	MCL (Chem-Rad), Single Sample	MCL	BCA Signed	2/25/2011
ELDON C STUTSMAN INC	165	JOHNSON	IA5221101	NTNC	201006588	Nitrate (as N)	30-Sep-10	MCL (Chem-Rad), Single Sample	MCL	BCA Signed	2/25/2011
ELDON C STUTSMAN INC	165	JOHNSON	IA5221101	NTNC	201100348	Nitrate (as N)	31-Oct-10	MCL (Chem-Rad), Single Sample	MCL	BCA Signed	2/25/2011
ELDON C STUTSMAN INC	165	JOHNSON	IA5221101	NTNC	201106916	Nitrate (as N)	30-Nov-10	MCL (Chem-Rad), Single Sample	MCL	BCA Signed	2/25/2011
ELK LODGE # 297	60	DUBUQUE	IA3100724	TNC	201100138	Coliform, Total (TCR)	30-Sep-10	Monitoring (TCR), Routine Major	MON	Compliance Achieved	12/6/2010
ELKADER GOLF & COUNTRY CLUB	45	CLAYTON	IA2223438	TNC	201006338	Coliform, Total (TCR)	31-Jul-10	Monitoring (TCR), Routine Major	MON	Compliance Achieved	8/2/2010
E-STOP	63	MILLS	IA6520201	TNC	201001319	Nitrate (as N)	30-Apr-10	Public Notice Rule Linked to Violation	PN	NOV Issued	4/15/2010
FAIRFIELD WATER SUPPLY	9602	JEFFERSON	IA5131033	CWS	201006361	Sodium	30-Jun-10	Monitoring (Chem-Rad), Routine Major	MON	Compliance Achieved	8/2/2010
FAITH LUTHERAN CHURCH (PALMER)	200	POCAHONTAS	IA7622802	TNC	201002149	Coliform, Total (TCR)	30-Jun-10	Monitoring (TCR), Routine Major	MON	Compliance Achieved	7/6/2010
FARMINGTON WATER SUPPLY	756	VAN BUREN	IA8930038	CWS	201006544	Failure to Issue Consumer Confidence Report	01-Jul-10	Consumer Confidence Report (CCR)	RPT	NOV Issued	9/2/2010
FAWN CREEK COUNTRY CLUB	50	JONES	IA5307811	TNC	201100163	Coliform, Total (TCR)	30-Sep-10	Monitoring (TCR), Routine Major	MON	Compliance Achieved	10/19/2010
FONDA WATER SUPPLY	665	POCAHONTAS	IA7603045	CWS	201107227	Nitrite (as N)	30-Nov-10	Monitoring (Chem-Rad), Routine Major	MON	Compliance Achieved	12/20/2010
FONTANA PARK-PICNIC AREA	37	BUCHANAN	IA1031401	TNC	201001816	Fecal Coliform	30-Jun-10	MCL (TCR), Acute	MCL	Compliance Achieved	1/25/2011
FONTANA PARK-PICNIC AREA	37	BUCHANAN	IA1031401	TNC	201001817	Coliform, Total (TCR)	30-Jun-10	MCL (TCR), Monthly	MCL	Compliance Achieved	1/25/2011

Name of the Public Water Supply (Alphabetical Listing)	Minimum Population Served	County	PWSID	PWS Type	Violation Number	Analyte	Compliance End Date	Violation	Violation Type	Enforcement Action	Enforcement Action Date
FONTANA PARK-PICNIC AREA	37	BUCHANAN	IA1031401	TNC	201002205	Coliform, Total (TCR)	30-Sep-10	MCL (TCR), Monthly	MCL	Compliance Achieved	1/25/2011
FONTANA PARK-PICNIC AREA	37	BUCHANAN	IA1031401	TNC	201002286	Coliform, Total (TCR)	31-Aug-10	MCL (TCR), Monthly	MCL	Compliance Achieved	1/25/2011
FONTANA PARK-PICNIC AREA	37	BUCHANAN	IA1031401	TNC	201100011	Coliform, Total (TCR)	30-Sep-10	MCL (TCR), Monthly	MCL	Compliance Achieved	1/25/2011
FONTANA PARK-PICNIC AREA	37	BUCHANAN	IA1031401	TNC	201100342	Coliform, Total (TCR)	31-Oct-10	MCL (TCR), Monthly	MCL	Compliance Achieved	1/25/2011
FONTANA PARK-PICNIC AREA	37	BUCHANAN	IA1031401	TNC	201107080	Coliform, Total (TCR)	30-Nov-10	MCL (TCR), Monthly	MCL	Compliance Achieved	1/25/2011
FONTANA PARK-PICNIC AREA	37	BUCHANAN	IA1031401	TNC	201107133	Coliform, Total (TCR)	31-Dec-10	MCL (TCR), Monthly	MCL	Compliance Achieved	1/25/2011
FONTANA PARK-PICNIC AREA	37	BUCHANAN	IA1031401	TNC	201107152	Coliform, Total (TCR)	30-Nov-10	Monitoring (TCR), Repeat Major	MON	Compliance Achieved	1/25/2011
FONTANA PARK-PICNIC AREA	37	BUCHANAN	IA1031401	TNC	201107241	Coliform, Total (TCR)	27-Nov-10	Monitoring (GWR), Source Major	MON	Compliance Achieved	1/25/2011
FONTANA PARK-PICNIC AREA	37	BUCHANAN	IA1031401	TNC	201107309	Coliform, Total (TCR)	31-Dec-10	Monitoring (TCR), Repeat Major	MON	Compliance Achieved	12/27/2010
FONTANA PARK-PICNIC AREA	37	BUCHANAN	IA1031401	TNC	201107426	Coliform, Total (TCR)	18-Dec-10	Monitoring (GWR), Source Major	MON	Compliance Achieved	1/25/2011
FOOD WASTE SOLUTIONS	60	LINN	IA5307101	NTNC	201001183	Nitrate (as N)	31-Mar-10	MCL (Chem-Rad), Single Sample	MCL	Compliance Achieved	2/4/2011
FOOD WASTE SOLUTIONS	60	LINN	IA5307101	NTNC	201001788	Nitrate (as N)	30-Jun-10	MCL (Chem-Rad), Single Sample	MCL	Compliance Achieved	2/4/2011
FOOD WASTE SOLUTIONS	60	LINN	IA5307101	NTNC	201001789	Nitrate (as N)	30-Jun-10	MCL (Chem-Rad), Single Sample	MCL	Compliance Achieved	2/4/2011
FOOD WASTE SOLUTIONS	60	LINN	IA5307101	NTNC	201006236	Coliform, Total (TCR)	31-Aug-10	MCL (TCR), Monthly	MCL	Compliance Achieved	10/21/2010
FOOD WASTE SOLUTIONS	60	LINN	IA5307101	NTNC	201006591	Nitrate (as N)	30-Sep-10	MCL (Chem-Rad), Single Sample	MCL	Compliance Achieved	2/4/2011
FOOD WASTE SOLUTIONS	60	LINN	IA5307101	NTNC	201100295	Coliform, Total (TCR)	26-Sep-10	Monitoring (GWR), Source Major	MON	Compliance Achieved	10/19/2010

Name of the Public Water Supply (Alphabetical Listing)	Minimum Population Served	County	PWSID	PWS Type	Violation Number	Analyte	Compliance End Date	Violation	Violation Type	Enforcement Action	Enforcement Action Date
FOOD WASTE SOLUTIONS	60	LINN	IA5307101	NTNC	201107269	Nitrate (as N)	31-Dec-10	MCL (Chem-Rad), Single Sample	MCL	Compliance Achieved	2/4/2011
FOREMOST FARMS (WAUKON)	35	ALLAMAKEE	IA0398101	TNC	201006396	Coliform, Total (TCR)	31-Jul-10	Monitoring (TCR), Routine Major	MON	Compliance Achieved	8/24/2010
FOREST OAK PROPERTIES	35	JOHNSON	IA5285209	TNC	201100256	Coliform, Total (TCR)	30-Sep-10	Monitoring (TCR), Routine Major	MON	Compliance Achieved	10/27/2010
FOREST OAK PROPERTIES	35	JOHNSON	IA5285209	TNC	201100346	Coliform, Total (TCR)	31-Dec-10	MCL (TCR), Monthly	MCL	Compliance Achieved	11/30/2010
FORT DODGE WATER SUPPLY	26309	WEBSTER	IA9433050	CWS	201001316	Failure to meet Compliance Schedule	13-Apr-10	Compliance Schedule	V/E	NOV Issued	4/13/2010
FOX VALLEY ACRES	36	MUSCATINE	IA7048319	CWS	201001660	Coliform, Total (TCR)	30-Jun-10	MCL (TCR), Monthly	MCL	Compliance Achieved	10/4/2010
FOX VALLEY ACRES	36	MUSCATINE	IA7048319	CWS	201001734	Coliform, Total (TCR)	31-May-10	Monitoring (TCR), Repeat Major	MON	Compliance Achieved	5/24/2010
FOX VALLEY ACRES	36	MUSCATINE	IA7048319	CWS	201001784	Coliform, Total (TCR)	15-May-10	Monitoring (GWR), Source Major	MON	Compliance Achieved	5/24/2010
FOX VALLEY ACRES	36	MUSCATINE	IA7048319	CWS	201002265	Coliform, Total (TCR)	31-Aug-10	MCL (TCR), Monthly	MCL	Compliance Achieved	10/4/2010
FREEZE FRAME BOWL	41	FLOYD	IA1253851	TNC	201002055	Coliform, Total (TCR)	30-Jun-10	Monitoring (TCR), Routine Major	MON	Compliance Achieved	9/24/2010
FRYTOWN WATER COOP	87	JOHNSON	IA5291301	CWS	201001792	Coliform, Total (TCR)	30-Jun-10	MCL (TCR), Monthly	MCL	Compliance Achieved	11/10/2010
FT MADISON MUNI WATER WORKS	11051	LEE	IA5625062	CWS	201006368	Sodium	30-Jun-10	Monitoring (Chem-Rad), Routine Major	MON	Compliance Achieved	9/22/2010
FUNCREST	25	JOHNSON	IA5225203	TNC	201002122	Nitrate (as N)	30-Jun-10	Monitoring (Chem-Rad), Routine Major	MON	Compliance Achieved	7/20/2010
GALLERY ACRES WEST	41	JOHNSON	IA5282306	CWS	201001164	Arsenic	31-Mar-10	MCL (Chem-Rad), Average	MCL	BCA Signed	2/9/2010
GALLERY ACRES WEST	41	JOHNSON	IA5282306	CWS	201001431	Arsenic	30-Jun-10	MCL (Chem-Rad), Average	MCL	BCA Signed	2/9/2010
GALLERY ACRES WEST	41	JOHNSON	IA5282306	CWS	201002211	Failure to meet Compliance Schedule	26-Jul-10	Compliance Schedule	V/E	BCA Signed	2/9/2010

Name of the Public Water Supply (Alphabetical Listing)	Minimum Population Served	County	PWSID	PWS Type	Violation Number	Analyte	Compliance End Date	Violation	Violation Type	Enforcement Action	Enforcement Action Date
GALLERY ACRES WEST	41	JOHNSON	IA5282306	CWS	201006203	Arsenic	30-Sep-10	MCL (Chem-Rad), Average	MCL	BCA Signed	2/9/2010
GALLERY ACRES WEST	41	JOHNSON	IA5282306	CWS	201107126	Arsenic	31-Dec-10	MCL (Chem-Rad), Average	MCL	BCA Signed	2/9/2010
GILLETT GROVE WATER SUPPLY	55	CLAY	IA2127085	CWS	201107072	Coliform, Total (TCR)	30-Nov-10	MCL (TCR), Monthly	MCL	Compliance Achieved	12/20/2010
GIRL SCOUTS E IOWA & W ILL /POLLYS	26	ALLAMAKEE	IA0315402	TNC	201001596	Coliform, Total (TCR)	30-Apr-10	Monitoring (TCR), Routine Major	MON	Compliance Achieved	5/5/2010
GLENN OAKS ADDITION	88	LINN	IA5784313	CWS	201001947	Coliform, Total (TCR)	31-Jul-10	MCL (TCR), Monthly	MCL	Compliance Achieved	1/25/2011
GLENWOOD MUNICIPAL UTILITIES	5740	MILLS	IA6525090	CWS	201001681	Total Trihalomethanes (TTHM)	30-Jun-10	MCL (Chem-Rad), Average	MCL	BCA Signed	5/12/2011
GLENWOOD MUNICIPAL UTILITIES	5740	MILLS	IA6525090	CWS	201006601	Total Trihalomethanes (TTHM)	30-Sep-10	MCL (Chem-Rad), Average	MCL	BCA Signed	5/12/2011
GLENWOOD MUNICIPAL UTILITIES	5740	MILLS	IA6525090	CWS	201106911	Total Trihalomethanes (TTHM)	31-Dec-10	MCL (Chem-Rad), Average	MCL	BCA Signed	5/12/2011
GOLD KEY MOTEL	58	FRANKLIN	IA3544720	TNC	201001151	Failure to meet Compliance Schedule	18-Feb-10	Compliance Schedule	V/E	NOV Issued	2/18/2010
GOLD KEY MOTEL	58	FRANKLIN	IA3544720	TNC	201001374	Coliform, Total (TCR)	31-Mar-10	Monitoring (TCR), Routine Major	MON	NOV Issued	4/26/2010
GOLD KEY MOTEL	58	FRANKLIN	IA3544720	TNC	201001532	Coliform, Total (TCR)	30-Apr-10	Monitoring (TCR), Routine Major	MON	NOV Issued	5/19/2010
GOLD KEY MOTEL	58	FRANKLIN	IA3544720	TNC	201001749	Coliform, Total (TCR)	31-May-10	Monitoring (TCR), Routine Major	MON	NOV Issued	6/21/2010
GOLD KEY MOTEL	58	FRANKLIN	IA3544720	TNC	201002082	Nitrate (as N)	30-Jun-10	Monitoring (Chem-Rad), Routine Major	MON	NOV Issued	7/20/2010
GOLD KEY MOTEL	58	FRANKLIN	IA3544720	TNC	201002083	Coliform, Total (TCR)	30-Jun-10	Monitoring (TCR), Routine Major	MON	NOV Issued	7/20/2010
GOLD KEY MOTEL	58	FRANKLIN	IA3544720	TNC	201006353	Coliform, Total (TCR)	31-Jul-10	Monitoring (TCR), Routine Major	MON	NOV Issued	8/19/2010
GOLD KEY MOTEL	58	FRANKLIN	IA3544720	TNC	201006735	Coliform, Total (TCR)	31-Aug-10	Monitoring (TCR), Routine Major	MON	NOV Issued	9/20/2010

Name of the Public Water Supply (Alphabetical Listing)	Minimum Population Served	County	PWSID	PWS Type	Violation Number	Analyte	Compliance End Date	Violation	Violation Type	Enforcement Action	Enforcement Action Date
GOLD KEY MOTEL	58	FRANKLIN	IA3544720	TNC	201100150	Coliform, Total (TCR)	30-Sep-10	Monitoring (TCR), Routine Major	MON	NOV Issued	12/3/2010
GOLD KEY MOTEL	58	FRANKLIN	IA3544720	TNC	201106978	Coliform, Total (TCR)	31-Oct-10	Monitoring (TCR), Routine Major	MON	NOV Issued	11/18/2010
GOLD KEY MOTEL	58	FRANKLIN	IA3544720	TNC	201107206	Coliform, Total (TCR)	30-Nov-10	Monitoring (TCR), Routine Major	MON	NOV Issued	12/17/2010
GOLD KEY MOTEL	58	FRANKLIN	IA3544720	TNC	201107352	Coliform, Total (TCR)	31-Dec-10	Monitoring (TCR), Routine Major	MON	NOV Issued	1/25/2011
GOLF SIDE GRILLE	30	DUBUQUE	IA3130731	TNC	201001371	Coliform, Total (TCR)	31-Mar-10	Monitoring (TCR), Routine Major	MON	Compliance Achieved	12/27/2010
GOLF SIDE GRILLE	30	DUBUQUE	IA3130731	TNC	201001526	Coliform, Total (TCR)	30-Apr-10	Monitoring (TCR), Routine Major	MON	Compliance Achieved	12/27/2010
GOLF SIDE GRILLE	30	DUBUQUE	IA3130731	TNC	201001747	Coliform, Total (TCR)	31-May-10	Monitoring (TCR), Routine Major	MON	Compliance Achieved	12/27/2010
GOLF SIDE GRILLE	30	DUBUQUE	IA3130731	TNC	201002075	Coliform, Total (TCR)	30-Jun-10	Monitoring (TCR), Routine Major	MON	Compliance Achieved	12/27/2010
GOLF SIDE GRILLE	30	DUBUQUE	IA3130731	TNC	201002076	Nitrate (as N)	30-Jun-10	Monitoring (Chem-Rad), Routine Major	MON	Compliance Achieved	12/17/2010
GOLF SIDE GRILLE	30	DUBUQUE	IA3130731	TNC	201006345	Coliform, Total (TCR)	31-Jul-10	Monitoring (TCR), Routine Major	MON	Compliance Achieved	12/27/2010
GOLF SIDE GRILLE	30	DUBUQUE	IA3130731	TNC	201006732	Coliform, Total (TCR)	31-Aug-10	Monitoring (TCR), Routine Major	MON	Compliance Achieved	12/27/2010
GOLF SIDE GRILLE	30	DUBUQUE	IA3130731	TNC	201100141	Nitrate (as N)	30-Sep-10	Monitoring (Chem-Rad), Routine Major	MON	Compliance Achieved	12/17/2010
GOLF SIDE GRILLE	30	DUBUQUE	IA3130731	TNC	201100142	Coliform, Total (TCR)	30-Sep-10	Monitoring (TCR), Routine Major	MON	Compliance Achieved	12/27/2010
GOLF SIDE GRILLE	30	DUBUQUE	IA3130731	TNC	201106976	Coliform, Total (TCR)	31-Oct-10	Monitoring (TCR), Routine Major	MON	Compliance Achieved	12/27/2010
GOLF SIDE GRILLE	30	DUBUQUE	IA3130731	TNC	201107205	Coliform, Total (TCR)	30-Nov-10	Monitoring (TCR), Routine Major	MON	Compliance Achieved	12/27/2010
GRANDMAS SNACK SHOP	46	BUTLER	IA1211821	TNC	201001079	Coliform, Total (TCR)	31-Jan-10	Monitoring (TCR), Routine Major	MON	Compliance Achieved	6/7/2010

Name of the Public Water Supply (Alphabetical Listing)	Minimum Population Served	County	PWSID	PWS Type	Violation Number	Analyte	Compliance End Date	Violation	Violation Type	Enforcement Action	Enforcement Action Date
GRANDMAS SNACK SHOP	46	BUTLER	IA1211821	TNC	201001210	Coliform, Total (TCR)	28-Feb-10	Monitoring (TCR), Routine Major	MON	Compliance Achieved	6/7/2010
GRANDMAS SNACK SHOP	46	BUTLER	IA1211821	TNC	201001355	Coliform, Total (TCR)	31-Mar-10	Monitoring (TCR), Routine Major	MON	Compliance Achieved	6/7/2010
GRANDMAS SNACK SHOP	46	BUTLER	IA1211821	TNC	201001517	Coliform, Total (TCR)	30-Apr-10	Monitoring (TCR), Routine Major	MON	Compliance Achieved	6/7/2010
GRANDMAS SNACK SHOP	46	BUTLER	IA1211821	TNC	201001640	Coliform, Total (TCR)	20-May-10	Public Notice Rule Linked to Violation	PN	AO w/ Penalty	9/23/2010
GRANDMAS SNACK SHOP	46	BUTLER	IA1211821	TNC	201001740	Coliform, Total (TCR)	31-May-10	Monitoring (TCR), Routine Major	MON	Compliance Achieved	6/7/2010
GRANDMAS SNACK SHOP	46	BUTLER	IA1211821	TNC	201006335	Coliform, Total (TCR)	31-Jul-10	Monitoring (TCR), Routine Major	MON	Compliance Achieved	2/14/2011
GRANDMAS SNACK SHOP	46	BUTLER	IA1211821	TNC	201006722	Coliform, Total (TCR)	31-Aug-10	Monitoring (TCR), Routine Major	MON	Compliance Achieved	2/14/2011
GRANDMAS SNACK SHOP	46	BUTLER	IA1211821	TNC	201100121	Coliform, Total (TCR)	30-Sep-10	Monitoring (TCR), Routine Major	MON	Compliance Achieved	2/14/2011
GRANDMAS SNACK SHOP	46	BUTLER	IA1211821	TNC	201106958	Coliform, Total (TCR)	31-Oct-10	Monitoring (TCR), Routine Major	MON	Compliance Achieved	2/14/2011
GRANDMAS SNACK SHOP	46	BUTLER	IA1211821	TNC	201107196	Coliform, Total (TCR)	30-Nov-10	Monitoring (TCR), Routine Major	MON	Compliance Achieved	2/14/2011
GRANDMAS SNACK SHOP	46	BUTLER	IA1211821	TNC	201107328	Coliform, Total (TCR)	31-Dec-10	Monitoring (TCR), Routine Major	MON	Compliance Achieved	2/14/2011
GRANDVIEW DRIVE IN	102	LOUISA	IA5842202	TNC	201107420	Coliform, Total (TCR)	31-Dec-10	Monitoring (TCR), Routine Major	MON	NOV Issued	1/20/2011
GREEN BRIER SUBDIVISION	47	DUBUQUE	IA3126307	CWS	201001437	Chlorine	31-Mar-10	Record Keeping	RPT	Compliance Achieved	4/26/2010
GREEN HILLS AEA	100	POTTAWATTAMIE	IA7820558	NTNC	201006437	Lead	30-Sep-10	AL (Pb/Cu), 90th Percentile	MCL	NOV Issued	8/20/2010
GREEN VALLEY GOLF COURSE	180	WOODBURY	IA9778201	TNC	201001270	Coliform, Total (TCR)	31-Mar-10	MCL (TCR), Monthly	MCL	Compliance Achieved	11/12/2010
GREEN VALLEY GOLF COURSE	180	WOODBURY	IA9778201	TNC	201001306	Coliform, Total (TCR)	30-Jun-10	MCL (TCR), Monthly	MCL	Compliance Achieved	11/12/2010

Name of the Public Water Supply (Alphabetical Listing)	Minimum Population Served	County	PWSID	PWS Type	Violation Number	Analyte	Compliance End Date	Violation	Violation Type	Enforcement Action	Enforcement Action Date
GREEN VALLEY GOLF COURSE	180	WOODBURY	IA9778201	TNC	201001408	Coliform, Total (TCR)	31-Mar-10	Monitoring (TCR), Routine Major	MON	Compliance Achieved	4/1/2010
GRISWOLD GOLF AND COUNTRY CLUB	43	CASS	IA1528809	TNC	201001292	Coliform, Total (TCR)	31-Mar-10	MCL (TCR), Monthly	MCL	Compliance Achieved	4/19/2010
GRISWOLD GOLF AND COUNTRY CLUB	43	CASS	IA1528809	TNC	201001659	Coliform, Total (TCR)	30-Jun-10	MCL (TCR), Monthly	MCL	Compliance Achieved	9/28/2010
GRISWOLD GOLF AND COUNTRY CLUB	43	CASS	IA1528809	TNC	201002229	Coliform, Total (TCR)	31-Jul-10	MCL (TCR), Monthly	MCL	Compliance Achieved	9/28/2010
GRISWOLD GOLF AND COUNTRY CLUB	43	CASS	IA1528809	TNC	201100085	Coliform, Total (TCR)	30-Sep-10	Monitoring (TCR), Repeat Major	MON	Compliance Achieved	11/23/2010
GRISWOLD GOLF AND COUNTRY CLUB	43	CASS	IA1528809	TNC	201100283	Coliform, Total (TCR)	06-Sep-10	Monitoring (GWR), Source Major	MON	Compliance Achieved	11/23/2010
GUTTENBERG GOLF & COUNTRY CLUB	129	CLAYTON	IA2242204	TNC	201006754	Nitrate (as N)	31-Aug-10	Monitoring (Chem-Rad), Routine Major	MON	Compliance Achieved	10/25/2010
GUTTENBERG GOLF & COUNTRY CLUB	129	CLAYTON	IA2242204	TNC	201006755	Nitrate (as N)	31-Aug-10	Monitoring (Chem-Rad), Routine Major	MON	Compliance Achieved	10/25/2010
GUTTENBERG GOLF & COUNTRY CLUB	129	CLAYTON	IA2242204	TNC	201100222	Nitrate (as N)	30-Sep-10	Monitoring (Chem-Rad), Routine Major	MON	Compliance Achieved	10/25/2010
GUTTENBERG GOLF & COUNTRY CLUB	129	CLAYTON	IA2242204	TNC	201107032	Nitrate (as N)	31-Oct-10	Monitoring (Chem-Rad), Routine Major	MON	NOV Issued	11/17/2010
HANFORD COMMUNITY CHURCH	52	CERRO GORDO	IA1739801	TNC	201002187	Coliform, Total (TCR)	30-Sep-10	MCL (TCR), Monthly	MCL	Compliance Achieved	9/29/2010
HANFORD COMMUNITY CHURCH	52	CERRO GORDO	IA1739801	TNC	201006483	Coliform, Total (TCR)	31-Aug-10	MCL (TCR), Monthly	MCL	Compliance Achieved	9/29/2010
HANLONTOWN WATER SUPPLY SYSTEM	244	WORTH	IA9830001	CWS	201100209	Total Trihalomethanes (TTHM)	31-Aug-10	Monitoring (Chem-Rad), Routine Major	MON	BCA Signed	10/29/2010
HANLONTOWN WATER SUPPLY SYSTEM	244	WORTH	IA9830001	CWS	201100210	Total Haloacetic Acids (HAA5)	31-Aug-10	Monitoring (DBP), Major	MON	BCA Signed	10/29/2010
HARMONY BIBLE CHURCH	195	HENRY	IA2915885	TNC	201001366	Coliform, Total (TCR)	31-Mar-10	Monitoring (TCR), Routine Major	MON	Compliance Achieved	7/6/2010
HARMONY BIBLE CHURCH	195	HENRY	IA2915885	TNC	201002067	Coliform, Total (TCR)	30-Jun-10	Monitoring (TCR), Routine Major	MON	Compliance Achieved	7/6/2010

Name of the Public Water Supply (Alphabetical Listing)	Minimum Population Served	County	PWSID	PWS Type	Violation Number	Analyte	Compliance End Date	Violation	Violation Type	Enforcement Action	Enforcement Action Date
HARMONY BIBLE CHURCH	195	HENRY	IA2915885	TNC	201107170	Coliform, Total (TCR)	30-Nov-10	Monitoring (TCR), Repeat Major	MON	Compliance Achieved	3/30/2011
HARPER WATER SUPPLY	134	KEOKUK	IA5428031	CWS	201107369	Coliform, Total (TCR)	31-Dec-10	Monitoring (TCR), Routine Major	MON	Compliance Achieved	1/4/2011
HARTWICK POINT WELL	120	DELAWARE	IA2817860	TNC	201001741	Nitrate (as N)	31-May-10	Monitoring (Chem-Rad), Routine Major	MON	Compliance Achieved	4/20/2010
HAVELOCK WATER SUPPLY	177	POCAHONTAS	IA7609039	CWS	201001754	Coliform, Total (TCR)	31-May-10	Monitoring (TCR), Routine Major	MON	Compliance Achieved	6/8/2010
HAWKEYE PRIDE EGG FARM LLP	80	HANCOCK	IA4109101	NTNC	201107423	Coliform, Total (TCR)	31-Dec-10	Monitoring (TCR), Routine Major	MON	Compliance Achieved	2/24/2011
HERITAGE UNITED METHODIST CHURCH	200	BREMER	IA0990808	TNC	201001129	Nitrate (as N)	31-Jan-10	Monitoring (Chem-Rad), Routine Major	MON	Compliance Achieved	2/1/2010
HERITAGE UNITED METHODIST CHURCH	200	BREMER	IA0990808	TNC	201001441	Nitrate (as N)	30-Apr-10	MCL (Chem-Rad), Single Sample	MCL	Compliance Achieved	10/20/2010
HI POINT GOLF COURSE	153	JOHNSON	IA5225802	TNC	201006861	Coliform, Total (TCR)	30-Sep-10	MCL (TCR), Monthly	MCL	Compliance Achieved	4/12/2011
HI POINT GOLF COURSE	153	JOHNSON	IA5225802	TNC	201100333	Coliform, Total (TCR)	31-Dec-10	MCL (TCR), Monthly	MCL	Compliance Achieved	4/12/2011
HICKORY ESTATES	48	SCOTT	IA8227301	CWS	201001034	Coliform, Total (TCR)	31-Jan-10	MCL (TCR), Monthly	MCL	Compliance Achieved	9/1/2010
HICKORY ESTATES	48	SCOTT	IA8227301	CWS	201001177	Coliform, Total (TCR)	31-Mar-10	MCL (TCR), Monthly	MCL	Compliance Achieved	9/1/2010
HICKORY ESTATES	48	SCOTT	IA8227301	CWS	201001881	Coliform, Total (TCR)	30-Jun-10	MCL (TCR), Monthly	MCL	Compliance Achieved	9/1/2010
HICKORY ESTATES	48	SCOTT	IA8227301	CWS	201006300	Coliform, Total (TCR)	31-Jul-10	Monitoring (TCR), Repeat Major	MON	Compliance Achieved	7/13/2010
HICKORY ESTATES	48	SCOTT	IA8227301	CWS	201006411	Coliform, Total (TCR)	11-Jul-10	Monitoring (GWR), Source Major	MON	Compliance Achieved	7/13/2010
HICKORY GROVE (GOLF COURSE)	28	FAYETTE	IA3353746	TNC	201001443	Nitrate (as N)	30-Apr-10	MCL (Chem-Rad), Single Sample	MCL	Compliance Achieved	9/23/2010
HICKORY GROVE (GOLF COURSE)	28	FAYETTE	IA3353746	TNC	201001450	Failure to use Treatment	30-Apr-10	Treatment Technique (Nitrate)	TT	Compliance Achieved	9/23/2010

Name of the Public Water Supply (Alphabetical Listing)	Minimum Population Served	County	PWSID	PWS Type	Violation Number	Analyte	Compliance End Date	Violation	Violation Type	Enforcement Action	Enforcement Action Date
HICKORY GROVE (GOLF COURSE)	28	FAYETTE	IA3353746	TNC	201002214	Nitrate (as N)	31-Jul-10	MCL (Chem-Rad), Single Sample	MCL	Compliance Achieved	9/23/2010
HICKORY HILLS SUBDIVISION #2	181	SCOTT	IA8215303	CWS	201006384	Gross Alpha, excluding Rn & U	30-Jun-10	Monitoring (Chem-Rad), Routine Major	MON	Compliance Achieved	9/14/2010
HICKORY HILLS SUBDIVISION #2	181	SCOTT	IA8215303	CWS	201006385	Radium, Combined (226, 228)	30-Jun-10	Monitoring (Chem-Rad), Routine Major	MON	Compliance Achieved	9/14/2010
HIDDEN ACRES SUBDIVISION	90	JOHNSON	IA5282308	CWS	201001685	Coliform, Total (TCR)	30-Jun-10	MCL (TCR), Monthly	MCL	Compliance Achieved	1/10/2011
HIDDEN HILLS GOLF COURSE	25	SCOTT	IA8209802	TNC	201002104	Nitrate (as N)	30-Jun-10	Monitoring (Chem-Rad), Routine Major	MON	NOV Issued	7/20/2010
HIDEAWAY HILLS MOBILE HOME PARK	40	ALLAMAKEE	IA0345603	CWS	201006750	Coliform, Total (TCR)	31-Aug-10	Monitoring (TCR), Routine Major	MON	Compliance Achieved	9/1/2010
HIDEAWAY HILLS MOBILE HOME PARK	40	ALLAMAKEE	IA0345603	CWS	201107464	Radium, Combined (226, 228)	31-Dec-10	MCL (Chem-Rad), Average	MCL	NOV Issued	2/14/2011
HIDE-A-WAY MANOR	82	LINN	IA5700641	CWS	201006556	Coliform, Total (TCR)	30-Sep-10	MCL (TCR), Monthly	MCL	Compliance Achieved	10/5/2010
HIGHLAND GENERAL STORE & CAMPGROUND	59	WINNESHIEK	IA9656401	TNC	201107410	Nitrate (as N)	31-Dec-10	Monitoring (Chem-Rad), Routine Major	MON	Compliance Achieved	2/7/2011
HILLS SCHOOL-IA CITY COMM SCHOOLS	193	JOHNSON	IA5221519	NTNC	201107641	Failure to meet Certified Operator Requirement	31-Dec-10	Certified Operator Requirement	STA	NOV Issued	2/23/2011
HILLSIDE STABLES RESTAURANT	57	JACKSON	IA4975201	TNC	201001907	Coliform, Total (TCR)	30-Sep-10	MCL (TCR), Monthly	MCL	Compliance Achieved	9/21/2010
HILLSIDE STABLES RESTAURANT	57	JACKSON	IA4975201	TNC	201002284	Coliform, Total (TCR)	31-Aug-10	MCL (TCR), Monthly	MCL	Compliance Achieved	9/21/2010
HILLSIDE WATER WORKS	30	WOODBURY	IA9743301	CWS	201107058	Coliform, Total (TCR)	31-Oct-10	Monitoring (TCR), Routine Major	MON	Compliance Achieved	11/1/2010
HILLTOP ROAD ASSOCIATION #1	45	MUSCATINE	IA7048392	CWS	201002198	Coliform, Total (TCR)	31-Jul-10	MCL (TCR), Monthly	MCL	Compliance Achieved	9/8/2010
HILLTOP ROAD ASSOCIATION #1	45	MUSCATINE	IA7048392	CWS	201002216	Fecal Coliform	31-Jul-10	MCL (TCR), Acute	MCL	Compliance Achieved	9/8/2010
HILLTOP ROAD ASSOCIATION #1	45	MUSCATINE	IA7048392	CWS	201006478	Coliform, Total (TCR)	31-Aug-10	MCL (TCR), Monthly	MCL	Compliance Achieved	9/8/2010

Name of the Public Water Supply (Alphabetical Listing)	Minimum Population Served	County	PWSID	PWS Type	Violation Number	Analyte	Compliance End Date	Violation	Violation Type	Enforcement Action	Enforcement Action Date
HOLDENS FOUNDATION SEEDS INC #4	34	IOWA	IA4884835	TNC	201001028	Coliform, Total (TCR)	31-Jan-10	MCL (TCR), Monthly	MCL	Compliance Achieved	7/2/2010
HOLDENS FOUNDATION SEEDS INC #4	34	IOWA	IA4884835	TNC	201001752	Coliform, Total (TCR)	31-May-10	Monitoring (TCR), Routine Major	MON	Compliance Achieved	6/21/2010
HORNICK WATER SUPPLY	253	WOODBURY	IA9738057	CWS	201001395	Nitrate (as N)	31-Mar-10	Monitoring (Chem-Rad), Routine Major	MON	Compliance Achieved	4/13/2010
HOSPERS MUNICIPAL WATER DEPT	687	SIOUX	IA8439058	CWS	201006386	Copper	30-Jun-10	Routine/Repeat Tap Sampling (Pb/Cu)	MON	Compliance Achieved	12/20/2010
HOSPERS MUNICIPAL WATER DEPT	687	SIOUX	IA8439058	CWS	201006387	Lead	30-Jun-10	Routine/Repeat Tap Sampling (Pb/Cu)	MON	Compliance Achieved	12/20/2010
HOWARD RESIDENTIAL CARE FACILITY	90	HOWARD	IA4500901	CWS	201006358	Nitrate (as N)	31-Jul-10	Monitoring (Chem-Rad), Routine Major	MON	Compliance Achieved	8/4/2010
HOWARD RESIDENTIAL CARE FACILITY	90	HOWARD	IA4500901	CWS	201107139	Lead	30-Sep-10	AL (Pb/Cu), 90th Percentile	MCL	BCA Signed	12/21/2010
HUBBARD GOLF & RECREATION	25	HARDIN	IA4254801	TNC	201002183	Coliform, Total (TCR)	30-Sep-10	MCL (TCR), Monthly	MCL	NOV Issued	7/29/2010
HUBBARD GOLF & RECREATION	25	HARDIN	IA4254801	TNC	201006504	Coliform, Total (TCR)	31-Aug-10	MCL (TCR), Monthly	MCL	NOV Issued	8/30/2010
HUBBARD GOLF & RECREATION	25	HARDIN	IA4254801	TNC	201100093	Coliform, Total (TCR)	30-Sep-10	Monitoring (TCR), Routine Major	MON	Compliance Achieved	10/19/2010
HUBBARD WATER SUPPLY	845	HARDIN	IA4254061	CWS	201001267	Arsenic	31-Mar-10	MCL (Chem-Rad), Average	MCL	Compliance Achieved	2/21/2011
HUBBARD WATER SUPPLY	845	HARDIN	IA4254061	CWS	201002006	Arsenic	30-Jun-10	MCL (Chem-Rad), Average	MCL	Compliance Achieved	2/21/2011
HWH CORPORATION (WEST)	50	CEDAR	IA7078101	NTNC	201001321	Coliform, Total (TCR)	30-Jun-10	MCL (TCR), Monthly	MCL	Compliance Achieved	2/7/2011
HWH CORPORATION (WEST)	50	CEDAR	IA7078101	NTNC	201001712	Coliform, Total (TCR)	31-May-10	Monitoring (TCR), Routine Major	MON	Compliance Achieved	7/14/2010
HWH CORPORATION (WEST)	50	CEDAR	IA7078101	NTNC	201107230	Coliform, Total (TCR)	30-Nov-10	Monitoring (TCR), Routine Major	MON	Compliance Achieved	2/7/2011
HWH CORPORATION (WEST)	50	CEDAR	IA7078101	NTNC	201107391	Coliform, Total (TCR)	31-Dec-10	Monitoring (TCR), Routine Major	MON	Compliance Achieved	2/7/2011

Name of the Public Water Supply (Alphabetical Listing)	Minimum Population Served	County	PWSID	PWS Type	Violation Number	Analyte	Compliance End Date	Violation	Violation Type	Enforcement Action	Enforcement Action Date
IDA GROVE WATER UTILITY	2373	IDA	IA4728067	CWS	201006878	Copper	30-Sep-10	AL (Pb/Cu), 90th Percentile	MCL	BCA Signed	10/27/2010
IOWA CITY REGENCY MOBILE HOME COMMUNITY	700	JOHNSON	IA5225673	CWS	201107519	Uranium	31-Dec-10	Monitoring (Chem-Rad), Routine Major	MON	Compliance Achieved	2/26/2011
IOWA STATE PENITENTIARY	1200	LEE	IA5600947	CWS	201006835	Total Trihalomethanes (TTHM)	31-May-10	Compliance Schedule	V/E	Compliance Achieved	10/29/2010
IOWA STATE PENITENTIARY	1200	LEE	IA5600947	CWS	201107123	Copper	30-Dec-10	AL (Pb/Cu), 90th Percentile	MCL	NOV Issued	12/3/2010
IOWA STATE PENITENTIARY	1200	LEE	IA5600947	CWS	201107457	Copper	30-Jun-10	AL (Pb/Cu), 90th Percentile	MCL	NOV Issued	2/8/2011
IRETON WATER SUPPLY	585	SIOUX	IA8447098	CWS	201100196	Coliform, Total (TCR)	30-Sep-10	Monitoring (TCR), Routine Major	MON	Compliance Achieved	10/13/2010
IZAAK WALTON LEAGUE-GREEN BAY CHAPTER	51	LEE	IA5625401	TNC	201001174	Nitrate (as N)	31-Mar-10	MCL (Chem-Rad), Single Sample	MCL	Compliance Achieved	12/7/2010
IZAAK WALTON LEAGUE-GREEN BAY CHAPTER	51	LEE	IA5625401	TNC	201001602	Nitrate (as N)	30-Apr-10	Monitoring (Chem-Rad), Routine Major	MON	Compliance Achieved	5/25/2010
JANESVILLE WATER SUPPLY	829	BREMER	IA0932001	CWS	201107193	Coliform, Total (TCR)	30-Nov-10	Monitoring (TCR), Routine Major	MON	Compliance Achieved	12/6/2010
JANESVILLE WATER SUPPLY	829	BREMER	IA0932001	CWS	201107194	Nitrate (as N)	30-Nov-10	Monitoring (Chem-Rad), Routine Major	MON	Compliance Achieved	12/6/2010
JANESVILLE WATER SUPPLY	829	BREMER	IA0932001	CWS	201107253	Chlorine Residual	30-Nov-10	Record Keeping	RPT	Compliance Achieved	12/6/2010
JERICO JOS	28	CHICKASAW	IA1951201	TNC	201002125	Coliform, Total (TCR)	30-Jun-10	Monitoring (TCR), Routine Major	MON	Compliance Achieved	1/31/2011
JERICO JOS	28	CHICKASAW	IA1951201	TNC	201100220	Coliform, Total (TCR)	30-Sep-10	Monitoring (TCR), Routine Major	MON	Compliance Achieved	1/31/2011
JERICO JOS	28	CHICKASAW	IA1951201	TNC	201100221	Nitrate (as N)	30-Sep-10	Monitoring (Chem-Rad), Routine Major	MON	NOV Issued	10/18/2010
JERICO JOS	28	CHICKASAW	IA1951201	TNC	201107397	Coliform, Total (TCR)	31-Dec-10	Monitoring (TCR), Routine Major	MON	Compliance Achieved	1/31/2011
JEWELL WATER SUPPLY	1215	HAMILTON	IA4027010	CWS	201107603	Lead	30-Sep-10	AL (Pb/Cu), 90th Percentile	MCL	NOV Issued	2/22/2011

Name of the Public Water Supply (Alphabetical Listing)	Minimum Population Served	County	PWSID	PWS Type	Violation Number	Analyte	Compliance End Date	Violation	Violation Type	Enforcement Action	Enforcement Action Date
JMD OIL INC	450	CEDAR	IA1600605	CWS	201002056	Coliform, Total (TCR)	30-Jun-10	Monitoring (TCR), Routine Major	MON	Compliance Achieved	7/6/2010
JMD OIL INC	450	CEDAR	IA1600605	CWS	201006543	Failure to Issue Consumer Confidence Report	01-Jul-10	Consumer Confidence Report (CCR)	RPT	NOV Issued	9/2/2010
JMD OIL INC	450	CEDAR	IA1600605	CWS	201107198	Coliform, Total (TCR)	30-Nov-10	Monitoring (TCR), Routine Major	MON	Compliance Achieved	12/7/2010
JOHN DEERE DUBUQUE WORKS	1900	DUBUQUE	IA3126116	NTNC	201001094	Coliform, Total (TCR)	31-Jan-10	Monitoring (TCR), Routine Major	MON	Compliance Achieved	3/4/2010
KALMES STORE	112	JACKSON	IA4979796	TNC	201002036	Coliform, Total (TCR)	30-Jun-10	Monitoring (TCR), Routine Major	MON	Compliance Achieved	7/28/2010
KNAPP MOBILE HOME COURT NO 4	87	DUBUQUE	IA3100602	CWS	201006215	Chlorine Residual, Free	30-Jun-10	Record Keeping	RPT	Compliance Achieved	12/7/2010
KNIGHTS FARM	25	LINN	IA5798201	TNC	201001776	Coliform, Total (TCR)	31-May-10	Monitoring (TCR), Routine Major	MON	Compliance Achieved	6/2/2010
KNIGHTS FARM	25	LINN	IA5798201	TNC	201107422	Coliform, Total (TCR)	31-Dec-10	Monitoring (TCR), Routine Major	MON	Compliance Achieved	1/4/2011
LACINA MEADOWS RESIDENTIAL SUBDIVISION	42	JOHNSON	IA5225328	CWS	201107844	Radium, Combined (226, 228)	31-Dec-10	Monitoring (Chem-Rad), Routine Major	MON	Compliance Achieved	4/26/2011
LACINA MEADOWS RESIDENTIAL SUBDIVISION	42	JOHNSON	IA5225328	CWS	201107845	Gross Alpha, excluding Rn & U	31-Dec-10	Monitoring (Chem-Rad), Routine Major	MON	BCA Signed	10/13/2008
LACINA MEADOWS RESIDENTIAL SUBDIVISION	42	JOHNSON	IA5225328	CWS	201107846	Uranium	31-Dec-10	Monitoring (Chem-Rad), Routine Major	MON	BCA Signed	10/13/2008
LAKE CORNELIA PARK - WRIGHT CO CONSERVAT	50	WRIGHT	IA9909901	TNC	201100211	Nitrite (as N)	30-Sep-10	Monitoring (Chem-Rad), Routine Major	MON	Compliance Achieved	1/24/2011
LAKE CORNELIA PARK - WRIGHT CO CONSERVAT	50	WRIGHT	IA9909901	TNC	201100212	Nitrate (as N)	30-Sep-10	Monitoring (Chem-Rad), Routine Major	MON	Compliance Achieved	1/24/2011
LAKE HENDRICKS PARK (EAST WELL)	192	HOWARD	IA4515957	TNC	201006818	Coliform, Total (TCR)	08-Aug-10	Monitoring (GWR), Source Major	MON	Compliance Achieved	10/12/2010
LAKE HENDRICKS PARK (WEST WELL)	29	HOWARD	IA4515958	TNC	201002227	Coliform, Total (TCR)	30-Sep-10	MCL (TCR), Monthly	MCL	Compliance Achieved	5/3/2011
LAKE HENDRICKS PARK (WEST WELL)	29	HOWARD	IA4515958	TNC	201006223	Fecal Coliform	30-Sep-10	MCL (TCR), Acute	MCL	Compliance Achieved	5/3/2011

Name of the Public Water Supply (Alphabetical Listing)	Minimum Population Served	County	PWSID	PWS Type	Violation Number	Analyte	Compliance End Date	Violation	Violation Type	Enforcement Action	Enforcement Action Date
LAKE HENDRICKS PARK (WEST WELL)	29	HOWARD	IA4515958	TNC	201006472	Coliform, Total (TCR)	31-Aug-10	MCL (TCR), Monthly	MCL	Compliance Achieved	5/3/2011
LAKE HENDRICKS PARK (WEST WELL)	29	HOWARD	IA4515958	TNC	201006620	Coliform, Total (TCR)	30-Sep-10	MCL (TCR), Monthly	MCL	Compliance Achieved	5/3/2011
LAKE HENDRICKS PARK (WEST WELL)	29	HOWARD	IA4515958	TNC	201100288	Coliform, Total (TCR)	26-Sep-10	Monitoring (GWR), Source Major	MON	Compliance Achieved	10/12/2010
LAKE HENDRICKS PARK (WEST WELL)	29	HOWARD	IA4515958	TNC	201106929	Coliform, Total (TCR)	31-Oct-10	Monitoring (TCR), Repeat Major	MON	Compliance Achieved	11/16/2010
LAKE HENDRICKS PARK (WEST WELL)	29	HOWARD	IA4515958	TNC	201107068	Coliform, Total (TCR)	24-Oct-10	Monitoring (GWR), Source Major	MON	Compliance Achieved	11/16/2010
LAKE MACBRIDE STATE PARK-EAST	27	JOHNSON	IA5282941	TNC	201006311	Coliform, Total (TCR)	31-Jul-10	Monitoring (TCR), Repeat Major	MON	Compliance Achieved	7/28/2010
LAKE RIDGE, INCORPORATED	900	JOHNSON	IA5225315	CWS	201001649	Failure to meet Certified Operator Requirement	31-May-10	Certified Operator Requirement	STA	Compliance Achieved	6/23/2010
LAKE SHORE RESORTS CLUB INC	65	FAYETTE	IA3353202	TNC	201006474	Coliform, Total (TCR)	30-Sep-10	MCL (TCR), Monthly	MCL	Compliance Achieved	10/11/2010
LAKEVIEW KNOLLS HOMEOWNERS ASSN.	122	JOHNSON	IA5200304	CWS	201001667	Coliform, Total (TCR)	30-Jun-10	MCL (TCR), Monthly	MCL	Compliance Achieved	9/7/2010
LAKEVIEW KNOLLS HOMEOWNERS ASSN.	122	JOHNSON	IA5200304	CWS	201002200	Coliform, Total (TCR)	31-Jul-10	MCL (TCR), Monthly	MCL	Compliance Achieved	9/7/2010
LAKEVIEW KNOLLS HOMEOWNERS ASSN.	122	JOHNSON	IA5200304	CWS	201006561	Failure to Obtain a Construction Permit	31-Aug-10	Construction Without Permit	STA	Compliance Achieved	11/9/2010
LAKEWOOD UTILITIES	200	WEBSTER	IA9433324	CWS	201001258	Coliform, Total (TCR)	24-Jan-10	Public Notice Rule Linked to Violation	PN	Compliance Achieved	3/31/2010
LAKEWOOD UTILITIES	200	WEBSTER	IA9433324	CWS	201006856	Failure to Issue Consumer Confidence Report	01-Jul-10	Consumer Confidence Report (CCR)	RPT	NOV Issued	9/27/2010
LARCHWOOD WATER SUPPLY	791	LYON	IA6050059	CWS	201107224	Coliform, Total (TCR)	30-Nov-10	Monitoring (TCR), Routine Major	MON	Compliance Achieved	12/20/2010
LARCHWOOD WATER SUPPLY	791	LYON	IA6050059	CWS	201107249	Chlorine	31-Dec-10	Monitoring (DBP), Major	MON	Compliance Achieved	3/31/2011
LAWTON WATER SUPPLY	963	WOODBURY	IA9743065	CWS	201107649	Failure to Obtain a Construction Permit	30-Nov-10	Construction Without Permit	STA	Compliance Achieved	3/4/2011

Name of the Public Water Supply (Alphabetical Listing)	Minimum Population Served	County	PWSID	PWS Type	Violation Number	Analyte	Compliance End Date	Violation	Violation Type	Enforcement Action	Enforcement Action Date
LEHIGH WATER SUPPLY	416	WEBSTER	IA9453071	CWS	201100202	Total Haloacetic Acids (HAA5)	31-Aug-10	Monitoring (DBP), Major	MON	BCA Signed	1/4/2011
LEHIGH WATER SUPPLY	416	WEBSTER	IA9453071	CWS	201100203	Total Trihalomethanes (TTHM)	31-Aug-10	Monitoring (Chem-Rad), Routine Major	MON	BCA Signed	1/4/2011
LETTS UNITED METHODIST CHURCH	26	LOUISA	IA5847820	TNC	201107380	Coliform, Total (TCR)	31-Dec-10	Monitoring (TCR), Routine Major	MON	Compliance Achieved	1/12/2011
LIDTKE PARK	50	HOWARD	IA4515901	TNC	201001511	Coliform, Total (TCR)	30-Apr-10	Monitoring (TCR), Routine Major	MON	Compliance Achieved	5/4/2010
LINCOLNWAY INVESTMENT GROUP	110	LINN	IA5748201	TNC	201107402	Nitrate (as N)	31-Dec-10	Monitoring (Chem-Rad), Routine Major	MON	Compliance Achieved	4/25/2011
LINN COUNTY CHAPTER IZAAK WALTON LEAGUE	52	LINN	IA5715211	TNC	201001059	Coliform, Total (TCR)	31-Jan-10	Monitoring (TCR), Routine Major	MON	Compliance Achieved	9/8/2010
LINN COUNTY CHAPTER IZAAK WALTON LEAGUE	52	LINN	IA5715211	TNC	201001412	Coliform, Total (TCR)	31-Mar-10	Monitoring (TCR), Routine Major	MON	Compliance Achieved	10/13/2010
LINN COUNTY CHAPTER IZAAK WALTON LEAGUE	52	LINN	IA5715211	TNC	201002145	Coliform, Total (TCR)	30-Jun-10	Monitoring (TCR), Routine Major	MON	Compliance Achieved	10/13/2010
LINN COUNTY CHAPTER IZAAK WALTON LEAGUE	52	LINN	IA5715211	TNC	201006582	Fecal Coliform	30-Sep-10	MCL (TCR), Acute	MCL	Compliance Achieved	4/11/2011
LINN COUNTY CHAPTER IZAAK WALTON LEAGUE	52	LINN	IA5715211	TNC	201006583	Coliform, Total (TCR)	30-Sep-10	MCL (TCR), Monthly	MCL	Compliance Achieved	4/11/2011
LINN COUNTY CHAPTER IZAAK WALTON LEAGUE	52	LINN	IA5715211	TNC	201100290	Coliform, Total (TCR)	20-Sep-10	Monitoring (GWR), Source Major	MON	Compliance Achieved	10/13/2010
LINN HOLLOW MHP	120	WASHINGTON	IA9200601	CWS	201001704	Coliform, Total (TCR)	30-Jun-10	MCL (TCR), Monthly	MCL	Compliance Achieved	1/10/2011
LINN HOLLOW MHP	120	WASHINGTON	IA9200601	CWS	201006542	Failure to Issue Consumer Confidence Report	01-Jul-10	Consumer Confidence Report (CCR)	RPT	Compliance Achieved	9/2/2010
LINN HOLLOW MHP	120	WASHINGTON	IA9200601	CWS	201107022	Coliform, Total (TCR)	31-Oct-10	Monitoring (TCR), Routine Major	MON	Compliance Achieved	11/1/2010
LISCOMB WATER SUPPLY	272	MARSHALL	IA6462087	CWS	201006371	Coliform, Total (TCR)	31-Jul-10	Monitoring (TCR), Routine Major	MON	Compliance Achieved	8/26/2010
LISCOMB WATER SUPPLY	272	MARSHALL	IA6462087	CWS	201006434	Chlorine	30-Sep-10	Monitoring (DBP), Major	MON	Compliance Achieved	8/26/2010

Name of the Public Water Supply (Alphabetical Listing)	Minimum Population Served	County	PWSID	PWS Type	Violation Number	Analyte	Compliance End Date	Violation	Violation Type	Enforcement Action	Enforcement Action Date
LITTLE ANGELS CHILD CARE CENTER	29	JOHNSON	IA5285501	NTNC	201001135	Coliform, Total (TCR)	31-Jan-10	Monitoring (TCR), Routine Major	MON	Compliance Achieved	2/8/2010
LITTLE ANGELS CHILD CARE CENTER	29	JOHNSON	IA5285501	NTNC	201006256	Coliform, Total (TCR)	31-Aug-10	MCL (TCR), Monthly	MCL	Compliance Achieved	10/4/2010
LITTLE BROWN CHURCH	183	CHICKASAW	IA1967863	TNC	201000850	Fecal Coliform	31-Mar-10	MCL (TCR), Acute	MCL	Compliance Achieved	9/1/2010
LITTLE BROWN CHURCH	183	CHICKASAW	IA1967863	TNC	201000851	Coliform, Total (TCR)	31-Mar-10	MCL (TCR), Monthly	MCL	Compliance Achieved	9/1/2010
LITTLE BROWN CHURCH	183	CHICKASAW	IA1967863	TNC	201001042	Coliform, Total (TCR)	28-Feb-10	MCL (TCR), Monthly	MCL	Compliance Achieved	9/1/2010
LITTLE BROWN CHURCH	183	CHICKASAW	IA1967863	TNC	201006723	Coliform, Total (TCR)	31-Aug-10	Monitoring (TCR), Routine Major	MON	Compliance Achieved	9/1/2010
LITTLE SIOUX SCOUT RANCH	25	HARRISON	IA7820431	TNC	201002223	Coliform, Total (TCR)	30-Sep-10	MCL (TCR), Monthly	MCL	Compliance Achieved	1/3/2011
LITTLE SIOUX SCOUT RANCH	25	HARRISON	IA7820431	TNC	201006599	Coliform, Total (TCR)	30-Sep-10	MCL (TCR), Monthly	MCL	Compliance Achieved	1/3/2011
LITTLE SIOUX SCOUT RANCH	25	HARRISON	IA7820431	TNC	201106899	Coliform, Total (TCR)	30-Nov-10	MCL (TCR), Monthly	MCL	Compliance Achieved	1/3/2011
LITTLE SIOUX SCOUT RANCH	25	HARRISON	IA7820431	TNC	201107244	Coliform, Total (TCR)	12-Nov-10	Monitoring (GWR), Source Major	MON	Compliance Achieved	11/18/2010
LITTLE SIOUX SCOUT RANCH	25	HARRISON	IA7820431	TNC	201107386	Nitrate (as N)	31-Dec-10	Monitoring (Chem-Rad), Routine Major	MON	Compliance Achieved	3/21/2011
LITTLEFIELD REC AREA	25	AUDUBON	IA0520905	TNC	201001624	Coliform, Total (TCR)	31-May-10	MCL (TCR), Monthly	MCL	Compliance Achieved	9/2/2010
LITTLEFIELD REC AREA	25	AUDUBON	IA0520905	TNC	201001655	Coliform, Total (TCR)	30-Jun-10	MCL (TCR), Monthly	MCL	Compliance Achieved	9/2/2010
LITTLEFIELD REC AREA	25	AUDUBON	IA0520905	TNC	201002167	Coliform, Total (TCR)	31-Jul-10	MCL (TCR), Monthly	MCL	Compliance Achieved	9/2/2010
LITTLEFIELD REC AREA	25	AUDUBON	IA0520905	TNC	201107101	Coliform, Total (TCR)	30-Nov-10	MCL (TCR), Monthly	MCL	BCA Signed	12/13/2010
LITTLEFIELD REC AREA	25	AUDUBON	IA0520905	TNC	201107313	Coliform, Total (TCR)	31-Dec-10	Monitoring (TCR), Repeat Major	MON	NOV Issued	1/19/2011

Name of the Public Water Supply (Alphabetical Listing)	Minimum Population Served	County	PWSID	PWS Type	Violation Number	Analyte	Compliance End Date	Violation	Violation Type	Enforcement Action	Enforcement Action Date
LITTLEFIELD REC AREA	25	AUDUBON	IA0520905	TNC	201107424	Coliform, Total (TCR)	09-Dec-10	Monitoring (GWR), Source Major	MON	NOV Issued	1/19/2011
LIVING HOPE COMMUNITY CHURCH	50	POTTAWATTAMIE	IA7820804	TNC	201100247	Nitrate (as N)	30-Sep-10	Monitoring (Chem-Rad), Routine Major	MON	Compliance Achieved	10/19/2010
LOCKRIDGE MUNI WATER SUPPLY	275	JEFFERSON	IA5157091	CWS	201100053	Coliform, Total (TCR)	30-Sep-10	Monitoring (TCR), Repeat Major	MON	Compliance Achieved	10/5/2010
LOGAN-MISSOURI VALLEY COUNTRY CLUB	105	HARRISON	IA4337201	TNC	201002124	Coliform, Total (TCR)	30-Jun-10	Monitoring (TCR), Routine Major	MON	Compliance Achieved	7/7/2010
LOGAN-MISSOURI VALLEY COUNTRY CLUB	105	HARRISON	IA4337201	TNC	201100219	Coliform, Total (TCR)	30-Sep-10	Monitoring (TCR), Routine Major	MON	Compliance Achieved	10/21/2010
LOMBARDIS	54	DUBUQUE	IA4910861	TNC	201001538	Coliform, Total (TCR)	30-Apr-10	Monitoring (TCR), Routine Major	MON	BCA Signed	1/27/2010
LOMBARDIS	54	DUBUQUE	IA4910861	TNC	201001753	Coliform, Total (TCR)	31-May-10	Monitoring (TCR), Routine Major	MON	BCA Signed	1/27/2010
LOMBARDIS	54	DUBUQUE	IA4910861	TNC	201002088	Coliform, Total (TCR)	30-Jun-10	Monitoring (TCR), Routine Major	MON	BCA Signed	1/27/2010
LOMBARDIS	54	DUBUQUE	IA4910861	TNC	201006360	Coliform, Total (TCR)	31-Jul-10	Monitoring (TCR), Routine Major	MON	BCA Signed	1/27/2010
LOMBARDIS	54	DUBUQUE	IA4910861	TNC	201006738	Coliform, Total (TCR)	31-Aug-10	Monitoring (TCR), Routine Major	MON	BCA Signed	1/27/2010
LOMBARDIS	54	DUBUQUE	IA4910861	TNC	201100158	Nitrate (as N)	30-Sep-10	Monitoring (Chem-Rad), Routine Major	MON	BCA Signed	1/27/2010
LOMBARDIS	54	DUBUQUE	IA4910861	TNC	201100159	Coliform, Total (TCR)	30-Sep-10	Monitoring (TCR), Routine Major	MON	BCA Signed	1/27/2010
LOMBARDIS	54	DUBUQUE	IA4910861	TNC	201106990	Coliform, Total (TCR)	31-Oct-10	Monitoring (TCR), Routine Major	MON	BCA Signed	1/27/2010
LOMBARDIS	54	DUBUQUE	IA4910861	TNC	201107212	Coliform, Total (TCR)	30-Nov-10	Monitoring (TCR), Routine Major	MON	BCA Signed	1/27/2010
LOMBARDIS	54	DUBUQUE	IA4910861	TNC	201107361	Coliform, Total (TCR)	31-Dec-10	Monitoring (TCR), Routine Major	MON	BCA Signed	1/27/2010
LONG BEACH MOBILE PARK	74	CERRO GORDO	IA1700642	CWS	201107452	Lead	30-Sep-10	AL (Pb/Cu), 90th Percentile	MCL	BCA Signed	3/11/2011

Name of the Public Water Supply (Alphabetical Listing)	Minimum Population Served	County	PWSID	PWS Type	Violation Number	Analyte	Compliance End Date	Violation	Violation Type	Enforcement Action	Enforcement Action Date
LOST ISLAND RESORT	30	CLAY	IA2109401	TNC	201100245	Coliform, Total (TCR)	30-Sep-10	Monitoring (TCR), Routine Major	MON	Compliance Achieved	11/2/2010
LOST ISLAND RESORT	30	CLAY	IA2109401	TNC	201100246	Coliform, Total (TCR)	30-Sep-10	Monitoring (TCR), Routine Major	MON	NOV Issued	10/18/2010
LOUISA CO LAW ENFORCEMENT CTR	46	LOUISA	IA5800901	CWS	201106905	Copper	30-Sep-10	Routine/Repeat Tap Sampling (Pb/Cu)	MON	BCA Signed	11/5/2010
LOUISA CO LAW ENFORCEMENT CTR	46	LOUISA	IA5800901	CWS	201106906	Lead	30-Sep-10	Routine/Repeat Tap Sampling (Pb/Cu)	MON	BCA Signed	11/5/2010
LOWELLS LANDING HOA	78	CLAYTON	IA2268837	TNC	201006429	Coliform, Total (TCR)	29-Jul-10	Monitoring (GWR), Source Major	MON	Compliance Achieved	8/3/2010
LOYAL ORDER OF THE MOOSE LODGE/C RAPIDS	70	LINN	IA5715209	TNC	201001400	Coliform, Total (TCR)	31-Mar-10	Monitoring (TCR), Routine Major	MON	Compliance Achieved	4/22/2010
LUCKY RESORT CAMPGROUND	105	CERRO GORDO	IA1759401	TNC	201002151	Coliform, Total (TCR)	30-Jun-10	Monitoring (TCR), Routine Major	MON	Compliance Achieved	10/5/2010
LUCKY RESORT CAMPGROUND	105	CERRO GORDO	IA1759401	TNC	201100259	Coliform, Total (TCR)	30-Sep-10	Monitoring (TCR), Routine Major	MON	Compliance Achieved	10/5/2010
LYNNVILLE WATER DEPT	366	JASPER	IA5047008	CWS	201100160	Total Haloacetic Acids (HAA5)	31-Aug-10	Monitoring (DBP), Major	MON	BCA Signed	2/8/2011
LYNNVILLE WATER DEPT	366	JASPER	IA5047008	CWS	201100161	Total Trihalomethanes (TTHM)	31-Aug-10	Monitoring (Chem-Rad), Routine Major	MON	BCA Signed	2/8/2011
LYON-SIOUX RWS-BIG SIOUX	1245	LYON	IA6000755	CWS	201100181	Nitrate (as N)	30-Sep-10	Monitoring (Chem-Rad), Routine Major	MON	Compliance Achieved	10/25/2010
MAGGIES DINER	41	CLAYTON	IA2258201	TNC	201002062	Nitrate (as N)	30-Jun-10	Monitoring (Chem-Rad), Routine Major	MON	Compliance Achieved	7/13/2010
MANCHESTER FISH HATCHERY	25	DELAWARE	IA2839996	TNC	201001994	Coliform, Total (TCR)	31-Jul-10	MCL (TCR), Monthly	MCL	Compliance Achieved	12/28/2010
MANCHESTER FISH HATCHERY	25	DELAWARE	IA2839996	TNC	201100285	Coliform, Total (TCR)	25-Sep-10	Monitoring (GWR), Source Major	MON	Compliance Achieved	10/26/2010
MANSON WATER SUPPLY	1692	CALHOUN	IA1351027	CWS	201001261	Failure to meet Compliance Schedule	17-Mar-10	Compliance Schedule	V/E	AO w/ Penalty	1/14/2011
MAPLE HILLS COUNTRY CLUB	55	BREMER	IA0975895	TNC	201001077	Coliform, Total (TCR)	31-Jan-10	Monitoring (TCR), Routine Major	MON	Compliance Achieved	3/9/2010

Name of the Public Water Supply (Alphabetical Listing)	Minimum Population Served	County	PWSID	PWS Type	Violation Number	Analyte	Compliance End Date	Violation	Violation Type	Enforcement Action	Enforcement Action Date
MAPLE HILLS COUNTRY CLUB	55	BREMER	IA0975895	TNC	201001209	Coliform, Total (TCR)	28-Feb-10	Monitoring (TCR), Routine Major	MON	Compliance Achieved	3/9/2010
MAPLE HILLS COUNTRY CLUB	55	BREMER	IA0975895	TNC	201106957	Coliform, Total (TCR)	31-Oct-10	Monitoring (TCR), Routine Major	MON	Compliance Achieved	4/20/2011
MAQUOKETA CAVES STATE PARK #3	50	JACKSON	IA4950923	TNC	201001594	Coliform, Total (TCR)	30-Apr-10	Monitoring (TCR), Routine Major	MON	Compliance Achieved	5/3/2010
MAQUOKETA CAVES STATE PARK #3	50	JACKSON	IA4950923	TNC	201107028	Coliform, Total (TCR)	31-Oct-10	Monitoring (TCR), Routine Major	MON	Compliance Achieved	4/28/2010
MARTHAS HILLTOP BAR & GRILL	34	JACKSON	IA4953202	TNC	201001857	Coliform, Total (TCR)	30-Jun-10	MCL (TCR), Monthly	MCL	Compliance Achieved	11/5/2010
MARTHAS HILLTOP BAR & GRILL	34	JACKSON	IA4953202	TNC	201006270	Coliform, Total (TCR)	31-Jul-10	Monitoring (TCR), Routine Major	MON	Compliance Achieved	11/5/2010
MARTHAS HILLTOP BAR & GRILL	34	JACKSON	IA4953202	TNC	201006425	Coliform, Total (TCR)	05-Jul-10	Monitoring (GWR), Source Major	MON	Compliance Achieved	11/5/2010
MARTHAS HILLTOP BAR & GRILL	34	JACKSON	IA4953202	TNC	201100258	Coliform, Total (TCR)	30-Sep-10	Monitoring (TCR), Routine Major	MON	Compliance Achieved	11/5/2010
MAYNES GROVE - FRANKLIN CO CONSERVATION	100	FRANKLIN	IA3544401	TNC	201002155	Nitrite (as N)	30-Jun-10	Monitoring (Chem-Rad), Routine Major	MON	Compliance Achieved	7/19/2010
MAYNES GROVE - FRANKLIN CO CONSERVATION	100	FRANKLIN	IA3544401	TNC	201002156	Nitrate (as N)	30-Jun-10	Monitoring (Chem-Rad), Routine Major	MON	Compliance Achieved	7/19/2010
MAYNES GROVE - FRANKLIN CO CONSERVATION	100	FRANKLIN	IA3544401	TNC	201002157	Coliform, Total (TCR)	30-Jun-10	Monitoring (TCR), Routine Major	MON	Compliance Achieved	7/19/2010
MCCALLSBURG WATER SUPPLY	318	STORY	IA8552010	CWS	201006389	Coliform, Total (TCR)	31-Jul-10	Monitoring (TCR), Routine Major	MON	Compliance Achieved	8/24/2010
MCCALLSBURG WATER SUPPLY	318	STORY	IA8552010	CWS	201006435	Chlorine	30-Sep-10	Monitoring (DBP), Major	MON	Compliance Achieved	8/24/2010
MELSHA TAP INC	25	JOHNSON	IA5285203	TNC	201107063	Coliform, Total (TCR)	30-Oct-10	Monitoring (GWR), Source Major	MON	Compliance Achieved	1/11/2011
MICKEYS VALLEY HALL	35	SCOTT	IA8271202	TNC	201002143	Coliform, Total (TCR)	30-Jun-10	Monitoring (TCR), Routine Major	MON	Compliance Achieved	10/26/2010
MICKEYS VALLEY HALL	35	SCOTT	IA8271202	TNC	201100239	Coliform, Total (TCR)	30-Sep-10	Monitoring (TCR), Routine Major	MON	Compliance Achieved	10/26/2010

Name of the Public Water Supply (Alphabetical Listing)	Minimum Population Served	County	PWSID	PWS Type	Violation Number	Analyte	Compliance End Date	Violation	Violation Type	Enforcement Action	Enforcement Action Date
MID RIVER MARINA	31	JOHNSON	IA5252202	TNC	201002129	Nitrate (as N)	30-Jun-10	Monitoring (Chem-Rad), Routine Major	MON	Compliance Achieved	4/28/2011
MID RIVER MARINA	31	JOHNSON	IA5252202	TNC	201002130	Coliform, Total (TCR)	30-Jun-10	Monitoring (TCR), Routine Major	MON	Compliance Achieved	4/28/2011
MID RIVER MARINA	31	JOHNSON	IA5252202	TNC	201006397	Coliform, Total (TCR)	31-Jul-10	Monitoring (TCR), Routine Major	MON	Compliance Achieved	4/28/2011
MID RIVER MARINA	31	JOHNSON	IA5252202	TNC	201006760	Coliform, Total (TCR)	31-Aug-10	Monitoring (TCR), Routine Major	MON	Compliance Achieved	4/28/2011
MID RIVER MARINA	31	JOHNSON	IA5252202	TNC	201100227	Coliform, Total (TCR)	30-Sep-10	Monitoring (TCR), Routine Major	MON	Compliance Achieved	4/28/2011
MID RIVER MARINA	31	JOHNSON	IA5252202	TNC	201107035	Coliform, Total (TCR)	31-Oct-10	Monitoring (TCR), Routine Major	MON	Compliance Achieved	4/28/2011
MIDDLETOWN WATER SUPPLY	318	DES MOINES	IA2952075	CWS	201107268	Total Trihalomethanes (TTHM)	31-Dec-10	MCL (Chem-Rad), Average	MCL	NOV Issued	12/27/2010
MIDWEST MFG (SHELL RK PROD-PK BLDGWELL)	25	BUTLER	IA1286107	TNC	201001240	Nitrate (as N)	28-Feb-10	Monitoring (Chem-Rad), Routine Major	MON	Compliance Achieved	3/18/2010
MIKES SALOON	240	PLYMOUTH	IA7528801	TNC	201001061	Coliform, Total (TCR)	31-Jan-10	Monitoring (TCR), Routine Major	MON	Compliance Achieved	6/17/2010
MIKES SALOON	240	PLYMOUTH	IA7528801	TNC	201001383	Nitrate (as N)	31-Mar-10	Monitoring (Chem-Rad), Routine Major	MON	Compliance Achieved	9/7/2010
MIKES SALOON	240	PLYMOUTH	IA7528801	TNC	201001384	Coliform, Total (TCR)	31-Mar-10	Monitoring (TCR), Routine Major	MON	Compliance Achieved	6/17/2010
MIKES SALOON	240	PLYMOUTH	IA7528801	TNC	201107383	Coliform, Total (TCR)	31-Dec-10	Monitoring (TCR), Routine Major	MON	Compliance Achieved	3/7/2011
MILE 600 LLC	50	DUBUQUE	IA3183877	TNC	201107346	Coliform, Total (TCR)	31-Dec-10	Monitoring (TCR), Routine Major	MON	Compliance Achieved	5/2/2011
MITCHELL COUNTY CARE FACILITY	27	MITCHELL	IA6600901	NTNC	201001664	Iowa Administrative Code	10-Jun-10	Monitoring (MOR)	MON	Compliance Achieved	8/4/2010
MITCHELL COUNTY CARE FACILITY	27	MITCHELL	IA6600901	NTNC	201100264	Coliform, Total (TCR)	25-Sep-10	Monitoring (GWR), Source Major	MON	Compliance Achieved	10/25/2010
MONDAMIN WATER SUPPLY	405	HARRISON	IA4349094	CWS	201006357	Coliform, Total (TCR)	31-Jul-10	Monitoring (TCR), Routine Major	MON	Compliance Achieved	8/8/2010

Name of the Public Water Supply (Alphabetical Listing)	Minimum Population Served	County	PWSID	PWS Type	Violation Number	Analyte	Compliance End Date	Violation	Violation Type	Enforcement Action	Enforcement Action Date
MONDAMIN WATER SUPPLY	405	HARRISON	IA4349094	CWS	201006433	Chlorine	30-Sep-10	Monitoring (DBP), Major	MON	Compliance Achieved	8/8/2010
MONDAMIN WATER SUPPLY	405	HARRISON	IA4349094	CWS	201100156	Total Haloacetic Acids (HAA5)	31-Aug-10	Monitoring (DBP), Major	MON	BCA Signed	10/19/2010
MONDAMIN WATER SUPPLY	405	HARRISON	IA4349094	CWS	201100157	Total Trihalomethanes (TTHM)	31-Aug-10	Monitoring (Chem-Rad), Routine Major	MON	BCA Signed	10/19/2010
MONONA MUNICIPAL WATER DEPT	1550	CLAYTON	IA2264095	CWS	201001436	Chlorine	31-Mar-10	Record Keeping	RPT	Compliance Achieved	7/27/2010
MONTAUK HISTORICAL SITE	462	FAYETTE	IA3317401	TNC	201006636	Coliform, Total (TCR)	31-Aug-10	Monitoring (TCR), Routine Major	MON	Compliance Achieved	10/4/2010
MOONEY HOLLOW BARN	102	JACKSON	IA4953201	TNC	201107415	Coliform, Total (TCR)	31-Dec-10	Monitoring (TCR), Routine Major	MON	Compliance Achieved	1/28/2011
MOONEY HOLLOW BARN	102	JACKSON	IA4953201	TNC	201107416	Nitrate (as N)	31-Dec-10	Monitoring (Chem-Rad), Routine Major	MON	Compliance Achieved	1/28/2011
MOONSHINE TAP	30	CHICKASAW	IA1974222	TNC	201001090	Coliform, Total (TCR)	31-Jan-10	Monitoring (TCR), Routine Major	MON	Compliance Achieved	6/29/2010
MOONSHINE TAP	30	CHICKASAW	IA1974222	TNC	201001215	Coliform, Total (TCR)	28-Feb-10	Monitoring (TCR), Routine Major	MON	Compliance Achieved	6/29/2010
MOONSHINE TAP	30	CHICKASAW	IA1974222	TNC	201006337	Coliform, Total (TCR)	31-Jul-10	Monitoring (TCR), Routine Major	MON	Compliance Achieved	9/22/2010
MOONSHINE TAP	30	CHICKASAW	IA1974222	TNC	201006724	Coliform, Total (TCR)	31-Aug-10	Monitoring (TCR), Routine Major	MON	Compliance Achieved	9/22/2010
MOONSHINE TAP	30	CHICKASAW	IA1974222	TNC	201107199	Coliform, Total (TCR)	30-Nov-10	Monitoring (TCR), Routine Major	MON	Compliance Achieved	2/28/2011
MOONSHINE TAP	30	CHICKASAW	IA1974222	TNC	201107334	Coliform, Total (TCR)	31-Dec-10	Monitoring (TCR), Routine Major	MON	Compliance Achieved	2/28/2011
MOORHEAD WATER SUPPLY	232	MONONA	IA6731006	CWS	201002209	Coliform, Total (TCR)	31-Jul-10	MCL (TCR), Monthly	MCL	Compliance Achieved	1/24/2011
MOORHEAD WATER SUPPLY	232	MONONA	IA6731006	CWS	201107461	Chlorine	31-Dec-10	Monitoring (DBP), Major	MON	NOV Issued	2/1/2011
MOUNT VERNON COMMUNITY BIBLE CHURCH	78	LINN	IA5758801	TNC	201001398	Coliform, Total (TCR)	31-Mar-10	Monitoring (TCR), Routine Major	MON	Compliance Achieved	4/18/2010

Name of the Public Water Supply (Alphabetical Listing)	Minimum Population Served	County	PWSID	PWS Type	Violation Number	Analyte	Compliance End Date	Violation	Violation Type	Enforcement Action	Enforcement Action Date
MOUNT VERNON COMMUNITY BIBLE CHURCH	78	LINN	IA5758801	TNC	201002121	Nitrate (as N)	30-Jun-10	Monitoring (Chem-Rad), Routine Major	MON	Compliance Achieved	10/12/2010
MOUNT VERNON COMMUNITY BIBLE CHURCH	78	LINN	IA5758801	TNC	201100215	Coliform, Total (TCR)	30-Sep-10	Monitoring (TCR), Routine Major	MON	Compliance Achieved	10/12/2010
MOUNT VERNON WATER SUPPLY	4171	LINN	IA5758021	CWS	201006214	Chlorine Residual, Free	30-Jun-10	Record Keeping	RPT	NOV Issued	8/9/2010
MT JOY MOBILE HOME PARK	173	SCOTT	IA8222603	CWS	201001590	Coliform, Total (TCR)	30-Apr-10	Monitoring (TCR), Routine Major	MON	Compliance Achieved	5/4/2010
MUSCATINE COM SCHOOL TRANSPORTATION BLDG	50	MUSCATINE	IA7048501	TNC	201001662	Coliform, Total (TCR)	30-Jun-10	MCL (TCR), Monthly	MCL	Compliance Achieved	7/29/2010
NASHUA WATER SUPPLY	1663	CHICKASAW	IA1967041	CWS	201001281	Chlorine	28-Feb-10	Record Keeping	RPT	Compliance Achieved	3/4/2010
NEMAHA WATER SUPPLY	43	SAC	IA8138042	CWS	201002189	Coliform, Total (TCR)	31-Jul-10	MCL (TCR), Monthly	MCL	NOV Issued	7/26/2010
NEMAHA WATER SUPPLY	43	SAC	IA8138042	CWS	201006585	Fecal Coliform	30-Sep-10	MCL (TCR), Acute	MCL	Compliance Achieved	1/26/2011
NEMAHA WATER SUPPLY	43	SAC	IA8138042	CWS	201006586	Coliform, Total (TCR)	30-Sep-10	MCL (TCR), Monthly	MCL	Compliance Achieved	1/26/2011
NEOLA LIGHT & WATER	845	POTTAWATTAMIE	IA7853043	CWS	201001585	1,2-Dichloroethane	31-Mar-10	Monitoring (Chem-Rad), Routine Major	MON	Compliance Achieved	4/7/2010
NEOLA LIGHT & WATER	845	POTTAWATTAMIE	IA7853043	CWS	201001586	Vinyl Chloride	31-Mar-10	Monitoring (Chem-Rad), Routine Major	MON	Compliance Achieved	4/7/2010
NEW ALBIN WATER SUPPLY	527	ALLAMAKEE	IA0370047	CWS	201107323	Coliform, Total (TCR)	31-Dec-10	Monitoring (TCR), Routine Major	MON	Compliance Achieved	1/10/2011
NEW ALBIN WATER SUPPLY	527	ALLAMAKEE	IA0370047	CWS	201107430	Chlorine	31-Dec-10	Monitoring (DBP), Major	MON	Compliance Achieved	1/10/2011
NEW HAMPTON RED POWER INC	75	CHICKASAW	IA1970101	TNC	201001867	Coliform, Total (TCR)	30-Jun-10	MCL (TCR), Monthly	MCL	Compliance Achieved	12/7/2010
NEW HAMPTON RED POWER INC	75	CHICKASAW	IA1970101	TNC	201100058	Coliform, Total (TCR)	30-Sep-10	Monitoring (TCR), Repeat Major	MON	Compliance Achieved	12/7/2010
NEW HAMPTON WATER SUPPLY	3571	CHICKASAW	IA1970051	CWS	201001282	Chlorine	28-Feb-10	Record Keeping	RPT	Compliance Achieved	3/15/2010

Name of the Public Water Supply (Alphabetical Listing)	Minimum Population Served	County	PWSID	PWS Type	Violation Number	Analyte	Compliance End Date	Violation	Violation Type	Enforcement Action	Enforcement Action Date
NEW HARTFORD WATER SUPPLY	516	BUTLER	IA1271058	CWS	201107093	Arsenic	31-Dec-10	MCL (Chem-Rad), Single Sample	MCL	BCA Signed	11/23/2010
NEW LIBERTY WATER SUPPLY	137	SCOTT	IA8264059	CWS	201000836	Coliform, Total (TCR)	31-Jan-10	MCL (TCR), Monthly	MCL	Compliance Achieved	8/2/2010
NEW WINE PARK	105	DUBUQUE	IA3126940	TNC	201001468	Nitrate (as N)	30-Jun-10	MCL (Chem-Rad), Average	MCL	Compliance Achieved	12/20/2010
NEW WINE PARK	105	DUBUQUE	IA3126940	TNC	201001645	Nitrate (as N)	30-Jun-10	MCL (Chem-Rad), Single Sample	MCL	Compliance Achieved	12/20/2010
NORTH LINN HIGH SCHOOL / MIDDLE SCHOOL	475	LINN	IA5722532	NTNC	201107374	Coliform, Total (TCR)	31-Dec-10	Monitoring (TCR), Routine Major	MON	Compliance Achieved	1/24/2011
NORTH TWIN VIEW HEIGHTS	180	JOHNSON	IA5200813	CWS	201107518	Sodium	31-Dec-10	Monitoring (Chem-Rad), Routine Major	MON	Compliance Achieved	3/5/2011
OAK VALLEY	154	LINN	IA5784311	CWS	201006308	Coliform, Total (TCR)	31-Jul-10	Monitoring (TCR), Repeat Major	MON	Compliance Achieved	8/3/2010
OAK VALLEY	154	LINN	IA5784311	CWS	201006412	Coliform, Total (TCR)	12-Jul-10	Monitoring (GWR), Source Major	MON	Compliance Achieved	8/3/2010
OAKGROVE CHRISTIAN CHURCH	140	BENTON	IA0670801	TNC	201100323	Fecal Coliform	31-Dec-10	MCL (TCR), Acute	MCL	Compliance Achieved	3/29/2011
OAKGROVE CHRISTIAN CHURCH	140	BENTON	IA0670801	TNC	201100324	Coliform, Total (TCR)	31-Dec-10	MCL (TCR), Monthly	MCL	Compliance Achieved	3/29/2011
OAKGROVE CHRISTIAN CHURCH	140	BENTON	IA0670801	TNC	201107103	Fecal Coliform	30-Nov-10	MCL (TCR), Acute	MCL	Compliance Achieved	3/29/2011
OAKGROVE CHRISTIAN CHURCH	140	BENTON	IA0670801	TNC	201107104	Coliform, Total (TCR)	30-Nov-10	MCL (TCR), Monthly	MCL	Compliance Achieved	3/29/2011
OAKVILLE WATER SUPPLY	439	LOUISA	IA5868085	CWS	201001112	Coliform, Total (TCR)	31-Jan-10	Monitoring (TCR), Routine Major	MON	Compliance Achieved	2/16/2010
OAKWOOD RV PARK	60	CERRO GORDO	IA1716801	TNC	201001978	Coliform, Total (TCR)	30-Sep-10	MCL (TCR), Monthly	MCL	Compliance Achieved	10/7/2010
OAKWOOD RV PARK	60	CERRO GORDO	IA1716801	TNC	201006840	Coliform, Total (TCR)	30-Sep-10	MCL (TCR), Monthly	MCL	Compliance Achieved	10/7/2010
ORCHARD WATER WORKS	71	MITCHELL	IA6668001	CWS	201100182	Total Trihalomethanes (TTHM)	31-Aug-10	Monitoring (Chem-Rad), Routine Major	MON	BCA Signed	10/25/2010

Name of the Public Water Supply (Alphabetical Listing)	Minimum Population Served	County	PWSID	PWS Type	Violation Number	Analyte	Compliance End Date	Violation	Violation Type	Enforcement Action	Enforcement Action Date
ORCHARD WATER WORKS	71	MITCHELL	IA6668001	CWS	201100183	Total Haloacetic Acids (HAA5)	31-Aug-10	Monitoring (DBP), Major	MON	BCA Signed	10/25/2010
OSBORNE OUTDOOR EDUCATION CENTER	84	CLAYTON	IA2223430	TNC	201006224	Coliform, Total (TCR)	31-Aug-10	MCL (TCR), Monthly	MCL	Compliance Achieved	11/8/2010
OSBORNE OUTDOOR EDUCATION CENTER	84	CLAYTON	IA2223430	TNC	201107187	Coliform, Total (TCR)	30-Nov-10	Monitoring (TCR), Repeat Major	MON	Compliance Achieved	11/8/2010
OSBORNE OUTDOOR EDUCATION CENTER	84	CLAYTON	IA2223430	TNC	201107248	Coliform, Total (TCR)	07-Nov-10	Monitoring (GWR), Source Major	MON	Compliance Achieved	11/8/2010
OSCEOLA WATER WORKS	4659	CLARKE	IA2038038	CWS	201001280	Chlorite	31-Mar-10	MCL (Chem-Rad), Average	MCL	Compliance Achieved	4/1/2010
OSTERDOCK STORE	26	CLAYTON	IA2242203	TNC	201001238	Coliform, Total (TCR)	28-Feb-10	Monitoring (TCR), Routine Major	MON	Compliance Achieved	3/25/2010
OSTERDOCK STORE	26	CLAYTON	IA2242203	TNC	201001469	Nitrate (as N)	30-Jun-10	MCL (Chem-Rad), Single Sample	MCL	Compliance Achieved	11/29/2010
OSTERDOCK STORE	26	CLAYTON	IA2242203	TNC	201006751	Coliform, Total (TCR)	31-Aug-10	Monitoring (TCR), Routine Major	MON	Compliance Achieved	9/29/2010
OSTERDOCK STORE	26	CLAYTON	IA2242203	TNC	201006752	Nitrate (as N)	31-Aug-10	Monitoring (Chem-Rad), Routine Major	MON	Compliance Achieved	9/8/2010
OYENS WATER SUPPLY	132	PLYMOUTH	IA7561021	CWS	201000853	Failure to meet Certified Operator Requirement	04-Jan-10	Certified Operator Requirement	STA	Compliance Achieved	2/17/2010
OYENS WATER SUPPLY	132	PLYMOUTH	IA7561021	CWS	201006848	Coliform, Total (TCR)	30-Sep-10	MCL (TCR), Monthly	MCL	Compliance Achieved	10/20/2010
PALISADES DOWS OBSERVATORY	50	LINN	IA5758401	TNC	201006418	Coliform, Total (TCR)	29-Jul-10	Monitoring (GWR), Source Major	MON	Compliance Achieved	10/21/2010
PALISADES DOWS OBSERVATORY	50	LINN	IA5758401	TNC	201100254	Coliform, Total (TCR)	30-Sep-10	Monitoring (TCR), Routine Major	MON	Compliance Achieved	10/21/2010
PALISADES KEPLER - PARK OFFICE	308	LINN	IA5751945	TNC	201001687	Coliform, Total (TCR)	30-Jun-10	MCL (TCR), Monthly	MCL	Compliance Achieved	9/14/2010
PALISADES KEPLER - PARK OFFICE	308	LINN	IA5751945	TNC	201001988	Coliform, Total (TCR)	31-Jul-10	MCL (TCR), Monthly	MCL	Compliance Achieved	9/14/2010
PALISADES KEPLER - PARK OFFICE	308	LINN	IA5751945	TNC	201006216	Coliform, Total (TCR)	31-Aug-10	MCL (TCR), Monthly	MCL	Compliance Achieved	9/14/2010

Name of the Public Water Supply (Alphabetical Listing)	Minimum Population Served	County	PWSID	PWS Type	Violation Number	Analyte	Compliance End Date	Violation	Violation Type	Enforcement Action	Enforcement Action Date
PALISADES KEPLER - PARK OFFICE	308	LINN	IA5751945	TNC	201006310	Coliform, Total (TCR)	31-Jul-10	Monitoring (TCR), Repeat Major	MON	Compliance Achieved	10/12/2010
PALISADES KEPLER - PARK OFFICE	308	LINN	IA5751945	TNC	201006669	Coliform, Total (TCR)	31-Aug-10	Monitoring (TCR), Repeat Major	MON	Compliance Achieved	10/12/2010
PALISADES KEPLER - PARK OFFICE	308	LINN	IA5751945	TNC	201006803	Coliform, Total (TCR)	30-Aug-10	Monitoring (GWR), Source Major	MON	Compliance Achieved	10/12/2010
PALO MINIMART	750	LINN	IA5765203	TNC	201001763	Coliform, Total (TCR)	31-May-10	Monitoring (TCR), Routine Major	MON	Compliance Achieved	6/9/2010
PARADISE VALLEY CAMPGROUND	55	CLAYTON	IA2234601	TNC	201107338	Coliform, Total (TCR)	31-Dec-10	Monitoring (TCR), Routine Major	MON	Compliance Achieved	5/16/2011
PARK AT SUNSET BEACH	40	DELAWARE	IA2800622	CWS	201006529	Failure to Issue Consumer Confidence Report	31-Jul-10	Consumer Confidence Report (CCR)	RPT	Compliance Achieved	9/23/2010
PARNELL WATER SUPPLY	193	IOWA	IA4863029	CWS	201001537	Coliform, Total (TCR)	30-Apr-10	Monitoring (TCR), Routine Major	MON	Compliance Achieved	5/4/2010
PARNELL WATER SUPPLY	193	IOWA	IA4863029	CWS	201106989	Coliform, Total (TCR)	31-Oct-10	Monitoring (TCR), Routine Major	MON	Compliance Achieved	11/2/2010
PENN CENTER, INC.	89	DELAWARE	IA2800901	CWS	201100133	Coliform, Total (TCR)	30-Sep-10	Monitoring (TCR), Routine Major	MON	Compliance Achieved	10/21/2010
PERRY MUNICIPAL WATER WORKS	7633	DALLAS	IA2561036	CWS	201002261	Nitrite (as N)	30-Sep-10	MCL (Chem-Rad), Single Sample	MCL	Compliance Achieved	1/18/2011
PERSHING UTILITIES CORP	485	MARION	IA6300800	CWS	201107135	Radium, Combined (226, 228)	31-Dec-10	MCL (Chem-Rad), Average	MCL	NOV Issued	12/8/2010
PIN OAK LINKS INC	50	DELAWARE	IA2839898	TNC	201002252	Coliform, Total (TCR)	30-Sep-10	MCL (TCR), Monthly	MCL	Compliance Achieved	4/13/2011
PIN OAK LINKS INC	50	DELAWARE	IA2839898	TNC	201107340	Coliform, Total (TCR)	31-Dec-10	Monitoring (TCR), Routine Major	MON	Compliance Achieved	4/13/2011
PIN OAK LINKS INC	50	DELAWARE	IA2839898	TNC	201107341	Nitrate (as N)	31-Dec-10	Monitoring (Chem-Rad), Routine Major	MON	Compliance Achieved	4/25/2011
PINE GROVE MENNONITE SCHOOL	36	HOWARD	IA4509501	NTNC	201106986	Coliform, Total (TCR)	31-Oct-10	Monitoring (TCR), Routine Major	MON	Compliance Achieved	11/30/2010
PINE LAKE CHRISTIAN CENTER	205	HARDIN	IA4236404	TNC	201001535	Nitrate (as N)	30-Apr-10	Monitoring (Chem-Rad), Routine Major	MON	Compliance Achieved	5/19/2010

Name of the Public Water Supply (Alphabetical Listing)	Minimum Population Served	County	PWSID	PWS Type	Violation Number	Analyte	Compliance End Date	Violation	Violation Type	Enforcement Action	Enforcement Action Date
PINE LAKE CHRISTIAN CENTER	205	HARDIN	IA4236404	TNC	201001536	Coliform, Total (TCR)	30-Apr-10	Monitoring (TCR), Routine Major	MON	Compliance Achieved	5/20/2010
PINEO GROVE WATER COMPANY	53	SCOTT	IA8273062	CWS	201001155	Coliform, Total (TCR)	28-Feb-10	MCL (TCR), Monthly	MCL	Compliance Achieved	1/18/2011
PINEO GROVE WATER COMPANY	53	SCOTT	IA8273062	CWS	201001180	Fecal Coliform	31-Mar-10	MCL (TCR), Acute	MCL	Compliance Achieved	1/18/2011
PINEO GROVE WATER COMPANY	53	SCOTT	IA8273062	CWS	201001181	Coliform, Total (TCR)	31-Mar-10	MCL (TCR), Monthly	MCL	Compliance Achieved	1/18/2011
PINEO GROVE WATER COMPANY	53	SCOTT	IA8273062	CWS	201006573	Coliform, Total (TCR)	30-Sep-10	Compliance Schedule	V/E	BCA Signed	3/26/2010
PINICON RIDGE C	150	LINN	IA5720907	TNC	201002180	Fecal Coliform	30-Sep-10	MCL (TCR), Acute	MCL	Compliance Achieved	12/20/2010
PINICON RIDGE C	150	LINN	IA5720907	TNC	201002181	Coliform, Total (TCR)	30-Sep-10	MCL (TCR), Monthly	MCL	Compliance Achieved	12/20/2010
PINICON RIDGE CAMPGROUNDS	150	LINN	IA5720905	TNC	201006426	Coliform, Total (TCR)	04-Jul-10	Monitoring (GWR), Source Major	MON	Compliance Achieved	10/13/2010
PIONEER HI-BRED DURANT PLANT	63	CEDAR	IA1636101	NTNC	201001425	Fecal Coliform	30-Jun-10	MCL (TCR), Acute	MCL	Compliance Achieved	11/1/2010
PIONEER HI-BRED DURANT PLANT	63	CEDAR	IA1636101	NTNC	201001426	Coliform, Total (TCR)	30-Jun-10	MCL (TCR), Monthly	MCL	Compliance Achieved	11/1/2010
PIONEER HI-BRED DURANT PLANT	63	CEDAR	IA1636101	NTNC	201001452	Coliform, Total (TCR)	31-May-10	MCL (TCR), Monthly	MCL	Compliance Achieved	11/1/2010
PIONEER HI-BRED DURANT PLANT	63	CEDAR	IA1636101	NTNC	201002057	Nitrate (as N)	30-Jun-10	Monitoring (Chem-Rad), Routine Major	MON	Compliance Achieved	9/17/2010
PLANTATION VILLAGE OWNERS ASSN INC	49	DES MOINES	IA2900600	CWS	201001365	Coliform, Total (TCR)	31-Mar-10	Monitoring (TCR), Routine Major	MON	Compliance Achieved	4/26/2010
PLANTATION VILLAGE OWNERS ASSN INC	49	DES MOINES	IA2900600	CWS	201107437	Iowa Administrative Code	31-Dec-10	Monitoring (MOR)	MON	NOV Issued	1/14/2011
PLEASANT CREEK ESTATES - PALO	45	LINN	IA5765302	CWS	201001134	Coliform, Total (TCR)	31-Jan-10	Monitoring (TCR), Routine Major	MON	Compliance Achieved	12/14/2010
PLEASANT CREEK ESTATES - PALO	45	LINN	IA5765302	CWS	201001242	Coliform, Total (TCR)	28-Feb-10	Monitoring (TCR), Routine Major	MON	Compliance Achieved	12/14/2010

Name of the Public Water Supply (Alphabetical Listing)	Minimum Population Served	County	PWSID	PWS Type	Violation Number	Analyte	Compliance End Date	Violation	Violation Type	Enforcement Action	Enforcement Action Date
PLEASANT CREEK ESTATES - PALO	45	LINN	IA5765302	CWS	201001402	Coliform, Total (TCR)	31-Mar-10	Monitoring (TCR), Routine Major	MON	Compliance Achieved	12/14/2010
PLEASANT CREEK ESTATES - PALO	45	LINN	IA5765302	CWS	201001601	Coliform, Total (TCR)	30-Apr-10	Monitoring (TCR), Routine Major	MON	Compliance Achieved	12/14/2010
PLEASANT CREEK ESTATES - PALO	45	LINN	IA5765302	CWS	201001768	Coliform, Total (TCR)	31-May-10	Monitoring (TCR), Routine Major	MON	Compliance Achieved	12/14/2010
PLEASANT CREEK ESTATES - PALO	45	LINN	IA5765302	CWS	201002132	Coliform, Total (TCR)	30-Jun-10	Monitoring (TCR), Routine Major	MON	Compliance Achieved	12/14/2010
PLEASANT CREEK ESTATES - PALO	45	LINN	IA5765302	CWS	201100228	Coliform, Total (TCR)	30-Sep-10	Monitoring (TCR), Routine Major	MON	Compliance Achieved	12/14/2010
PLEASANT CREEK ESTATES - PALO	45	LINN	IA5765302	CWS	201100229	Nitrate (as N)	30-Sep-10	Monitoring (Chem-Rad), Routine Major	MON	Compliance Achieved	3/3/2011
PLEASANT CREEK ESTATES - PALO	45	LINN	IA5765302	CWS	201107036	Coliform, Total (TCR)	31-Oct-10	Monitoring (TCR), Routine Major	MON	Compliance Achieved	12/14/2010
PLEASANT CREEK ESTATES - PALO	45	LINN	IA5765302	CWS	201107037	Copper	30-Sep-10	Routine/Repeat Tap Sampling (Pb/Cu)	MON	BCA Signed	2/8/2011
PLEASANT CREEK ESTATES - PALO	45	LINN	IA5765302	CWS	201107038	Lead	30-Sep-10	Routine/Repeat Tap Sampling (Pb/Cu)	MON	BCA Signed	2/8/2011
PLUM CREEK GOLF CLUB	25	CHICKASAW	IA1940827	TNC	201002058	Coliform, Total (TCR)	30-Jun-10	Monitoring (TCR), Routine Major	MON	Compliance Achieved	7/29/2010
PLUM CREEK GOLF CLUB	25	CHICKASAW	IA1940827	TNC	201002059	Coliform, Total (TCR)	30-Jun-10	Monitoring (TCR), Routine Major	MON	Compliance Achieved	7/20/2010
PLUM CREEK GOLF CLUB	25	CHICKASAW	IA1940827	TNC	201100124	Coliform, Total (TCR)	30-Sep-10	Monitoring (TCR), Routine Major	MON	Compliance Achieved	10/18/2010
PLUM RIVER GOLF COURSE	100	JACKSON	IA4965201	TNC	201001514	Coliform, Total (TCR)	30-Apr-10	Monitoring (TCR), Routine Major	MON	Compliance Achieved	6/11/2010
PLUM RIVER GOLF COURSE	100	JACKSON	IA4965201	TNC	201001765	Coliform, Total (TCR)	31-May-10	Monitoring (TCR), Routine Major	MON	Compliance Achieved	6/11/2010
PONY CREEK #1 HOA/PEOPLES SERVICE	125	MILLS	IA6500823	CWS	201107460	Chlorine	31-Dec-10	Monitoring (DBP), Major	MON	Compliance Achieved	2/3/2011
POTSIE INC	53	JACKSON	IA4982201	TNC	201001029	Failure to Obtain a Construction Permit	31-Jan-10	Construction Without Permit	STA	Compliance Achieved	8/6/2010

Name of the Public Water Supply (Alphabetical Listing)	Minimum Population Served	County	PWSID	PWS Type	Violation Number	Analyte	Compliance End Date	Violation	Violation Type	Enforcement Action	Enforcement Action Date
POTSIE INC	53	JACKSON	IA4982201	TNC	201001138	Coliform, Total (TCR)	31-Jan-10	Monitoring (TCR), Routine Major	MON	Compliance Achieved	3/30/2010
POTSIE INC	53	JACKSON	IA4982201	TNC	201001413	Nitrate (as N)	31-Mar-10	Monitoring (Chem-Rad), Routine Major	MON	Compliance Achieved	4/26/2010
POTSIE INC	53	JACKSON	IA4982201	TNC	201001414	Nitrite (as N)	31-Mar-10	Monitoring (Chem-Rad), Routine Major	MON	Compliance Achieved	4/26/2010
POTSIE INC	53	JACKSON	IA4982201	TNC	201002288	Coliform, Total (TCR)	30-Jun-10	Monitoring (TCR), Routine Major	MON	Compliance Achieved	7/27/2010
PRAIRIE VIEW ESTATES HOA	155	JOHNSON	IA5225326	CWS	201001192	Coliform, Total (TCR)	28-Feb-10	Monitoring (TCR), Routine Major	MON	Compliance Achieved	3/27/2010
PRAIRIE VIEW ESTATES HOA	155	JOHNSON	IA5225326	CWS	201001243	Coliform, Total (TCR)	28-Feb-10	Monitoring (TCR), Routine Major	MON	Compliance Achieved	3/1/2010
PRAIRIE VIEW ESTATES HOA	155	JOHNSON	IA5225326	CWS	201001244	Coliform, Total (TCR)	28-Feb-10	Monitoring (TCR), Routine Major	MON	Compliance Achieved	3/27/2010
PRAIRIE VIEW ESTATES HOA	155	JOHNSON	IA5225326	CWS	201001620	Coliform, Total (TCR)	31-May-10	MCL (TCR), Monthly	MCL	Compliance Achieved	2/26/2011
PRAIRIE VIEW ESTATES HOA	155	JOHNSON	IA5225326	CWS	201002018	Coliform, Total (TCR)	30-Jun-10	Monitoring (TCR), Repeat Major	MON	Compliance Achieved	10/29/2010
PRAIRIE VIEW ESTATES HOA	155	JOHNSON	IA5225326	CWS	201002025	Coliform, Total (TCR)	30-Jun-10	Monitoring (TCR), Repeat Major	MON	Compliance Achieved	9/10/2010
PRAIRIE VIEW ESTATES HOA	155	JOHNSON	IA5225326	CWS	201002033	Coliform, Total (TCR)	30-Jun-10	Monitoring (TCR), Routine Major	MON	Compliance Achieved	8/15/2010
PRAIRIE VIEW ESTATES HOA	155	JOHNSON	IA5225326	CWS	201002042	Coliform, Total (TCR)	30-Jun-10	Monitoring (TCR), Routine Major	MON	Compliance Achieved	7/30/2010
PRAIRIE VIEW ESTATES HOA	155	JOHNSON	IA5225326	CWS	201002133	Coliform, Total (TCR)	30-Jun-10	Monitoring (TCR), Routine Major	MON	Compliance Achieved	9/10/2010
PRAIRIE VIEW ESTATES HOA	155	JOHNSON	IA5225326	CWS	201002134	Coliform, Total (TCR)	30-Jun-10	Monitoring (TCR), Routine Major	MON	Compliance Achieved	8/15/2010
PRAIRIE VIEW ESTATES HOA	155	JOHNSON	IA5225326	CWS	201002135	Coliform, Total (TCR)	30-Jun-10	Monitoring (TCR), Routine Major	MON	Compliance Achieved	7/30/2010
PRAIRIE VIEW ESTATES HOA	155	JOHNSON	IA5225326	CWS	201002136	Coliform, Total (TCR)	30-Jun-10	Monitoring (TCR), Routine Major	MON	Compliance Achieved	8/16/2010

Name of the Public Water Supply (Alphabetical Listing)	Minimum Population Served	County	PWSID	PWS Type	Violation Number	Analyte	Compliance End Date	Violation	Violation Type	Enforcement Action	Enforcement Action Date
PRAIRIE VIEW ESTATES HOA	155	JOHNSON	IA5225326	CWS	201006400	Coliform, Total (TCR)	31-Jul-10	Monitoring (TCR), Routine Major	MON	Compliance Achieved	8/15/2010
PRAIRIE VIEW ESTATES HOA	155	JOHNSON	IA5225326	CWS	201006401	Coliform, Total (TCR)	31-Jul-10	Monitoring (TCR), Routine Major	MON	Compliance Achieved	8/15/2010
PRAIRIE VIEW ESTATES HOA	155	JOHNSON	IA5225326	CWS	201006595	Coliform, Total (TCR)	30-Sep-10	MCL (TCR), Monthly	MCL	Compliance Achieved	2/26/2011
PRAIRIE VIEW ESTATES HOA	155	JOHNSON	IA5225326	CWS	201006658	Coliform, Total (TCR)	31-Aug-10	Monitoring (TCR), Repeat Major	MON	Compliance Achieved	10/29/2010
PRAIRIE VIEW ESTATES HOA	155	JOHNSON	IA5225326	CWS	201006704	Coliform, Total (TCR)	31-Aug-10	Monitoring (TCR), Repeat Major	MON	Compliance Achieved	10/29/2010
PRAIRIE VIEW ESTATES HOA	155	JOHNSON	IA5225326	CWS	201100070	Coliform, Total (TCR)	30-Sep-10	Monitoring (TCR), Repeat Major	MON	Compliance Achieved	10/29/2010
PRAIRIE VIEW ESTATES HOA	155	JOHNSON	IA5225326	CWS	201100071	Coliform, Total (TCR)	30-Sep-10	Monitoring (TCR), Routine Major	MON	Compliance Achieved	10/29/2010
PRAIRIE VIEW ESTATES HOA	155	JOHNSON	IA5225326	CWS	201100230	Nitrate (as N)	30-Sep-10	Monitoring (Chem-Rad), Routine Major	MON	Compliance Achieved	4/25/2011
PRAIRIE VIEW ESTATES HOA	155	JOHNSON	IA5225326	CWS	201100231	Coliform, Total (TCR)	30-Sep-10	Monitoring (TCR), Routine Major	MON	Compliance Achieved	10/29/2010
PRAIRIE VIEW ESTATES HOA	155	JOHNSON	IA5225326	CWS	201100232	Nitrate (as N)	30-Sep-10	Monitoring (Chem-Rad), Routine Major	MON	BCA Signed	5/9/2011
PRAIRIE VIEW ESTATES HOA	155	JOHNSON	IA5225326	CWS	201106893	Coliform, Total (TCR)	31-Oct-10	MCL (TCR), Monthly	MCL	Compliance Achieved	2/26/2011
PRAIRIE VIEW ESTATES HOA	155	JOHNSON	IA5225326	CWS	201107039	Sodium	30-Sep-10	Monitoring (Chem-Rad), Routine Major	MON	BCA Signed	5/9/2011
PRAIRIE VIEW ESTATES HOA	155	JOHNSON	IA5225326	CWS	201107150	Coliform, Total (TCR)	30-Nov-10	Monitoring (TCR), Repeat Major	MON	Compliance Achieved	2/26/2011
PRAIRIE VIEW ESTATES HOA	155	JOHNSON	IA5225326	CWS	201107151	Coliform, Total (TCR)	30-Nov-10	Monitoring (TCR), Repeat Major	MON	Compliance Achieved	2/26/2011
PRAIRIE VILLAGE MOBILE HOME PK	200	DALLAS	IA2500600	CWS	201006467	Copper	30-Sep-10	AL (Pb/Cu), 90th Percentile	MCL	NOV Issued	8/26/2010
PRIME TIME RESTAURANT & SPORTS LOUNGE	110	KOSSUTH	IA5502731	TNC	201002089	Nitrate (as N)	30-Jun-10	Monitoring (Chem-Rad), Routine Major	MON	Compliance Achieved	7/20/2010

Name of the Public Water Supply (Alphabetical Listing)	Minimum Population Served	County	PWSID	PWS Type	Violation Number	Analyte	Compliance End Date	Violation	Violation Type	Enforcement Action	Enforcement Action Date
PRIMERA FOODS	65	HANCOCK	IA4103101	NTNC	201006458	Lead & Copper Rule	30-Jun-10	Initial Tap Sampling (Pb/Cu)	MON	Compliance Achieved	9/2/2010
PRIMERA FOODS	65	HANCOCK	IA4103101	NTNC	201107357	Coliform, Total (TCR)	31-Dec-10	Monitoring (TCR), Routine Major	MON	Compliance Achieved	1/24/2011
QUAIL RUN COUNTRY CLUB	45	POTTAWATTAMIE	IA7853801	TNC	201001595	Coliform, Total (TCR)	30-Apr-10	Monitoring (TCR), Routine Major	MON	Compliance Achieved	5/3/2010
QUAIL RUN COUNTRY CLUB	45	POTTAWATTAMIE	IA7853801	TNC	201001633	Coliform, Total (TCR)	31-May-10	MCL (TCR), Monthly	MCL	Compliance Achieved	6/28/2010
QUAKERDALE	60	HARDIN	IA4271901	CWS	201006836	Coliform, Total (TCR)	30-Sep-10	MCL (TCR), Monthly	MCL	Compliance Achieved	12/14/2010
QUAKERDALE	60	HARDIN	IA4271901	CWS	201107099	Coliform, Total (TCR)	30-Nov-10	MCL (TCR), Monthly	MCL	Compliance Achieved	12/14/2010
QUALITY WATER, INC. #2 (K-L)	70	DUBUQUE	IA3126303	CWS	201107110	Coliform, Total (TCR)	30-Nov-10	MCL (TCR), Monthly	MCL	Compliance Achieved	12/16/2010
RABINER TREATMENT CENTER	156	WEBSTER	IA9433801	CWS	201107041	Coliform, Total (TCR)	31-Oct-10	Monitoring (TCR), Routine Major	MON	Compliance Achieved	11/9/2010
RABINER TREATMENT CENTER	156	WEBSTER	IA9433801	CWS	201107087	Chlorine	31-Oct-10	Monitoring (DBP), Major	MON	Compliance Achieved	1/11/2011
RACERS BAR & GRILL	105	KOSSUTH	IA5502203	TNC	201001253	Coliform, Total (TCR)	28-Feb-10	Public Notice Rule Linked to Violation	PN	NOV Issued	3/16/2010
RACERS BAR & GRILL	105	KOSSUTH	IA5502203	TNC	201001769	Coliform, Total (TCR)	31-May-10	Monitoring (TCR), Routine Major	MON	Compliance Achieved	6/8/2010
RAINBOW CLUB	50	JONES	IA5307728	TNC	201106999	Coliform, Total (TCR)	31-Oct-10	Monitoring (TCR), Routine Major	MON	Compliance Achieved	12/2/2010
RALEIGH HILLS GOLF COURSE	66	CHICKASAW	IA1946201	TNC	201002126	Coliform, Total (TCR)	30-Jun-10	Monitoring (TCR), Routine Major	MON	Compliance Achieved	7/28/2010
RAUSCH PETROLEM LIMITED CO	89	CLAYTON	IA2242205	TNC	201006295	Coliform, Total (TCR)	31-Jul-10	Monitoring (TCR), Repeat Major	MON	Compliance Achieved	8/26/2010
RAUSCH PETROLEM LIMITED CO	89	CLAYTON	IA2242205	TNC	201006408	Coliform, Total (TCR)	05-Jul-10	Monitoring (GWR), Source Major	MON	Compliance Achieved	8/26/2010
REDWING ESTATES HOA	40	JOHNSON	IA5225313	CWS	201006541	Failure to Issue Consumer Confidence Report	01-Jul-10	Consumer Confidence Report (CCR)	RPT	NOV Issued	9/2/2010

Name of the Public Water Supply (Alphabetical Listing)	Minimum Population Served	County	PWSID	PWS Type	Violation Number	Analyte	Compliance End Date	Violation	Violation Type	Enforcement Action	Enforcement Action Date
REINBECK WATER SUPPLY	1664	GRUNDY	IA3870073	CWS	201001842	Coliform, Total (TCR)	30-Jun-10	MCL (TCR), Monthly	MCL	Compliance Achieved	7/14/2010
REINBECK WATER SUPPLY	1664	GRUNDY	IA3870073	CWS	201107209	Coliform, Total (TCR)	30-Nov-10	Monitoring (TCR), Routine Major	MON	Compliance Achieved	12/15/2010
REINBECK WATER SUPPLY	1664	GRUNDY	IA3870073	CWS	201107257	Chlorine	30-Nov-10	Monitoring (DBP), Major	MON	Compliance Achieved	2/3/2011
REVELLE 6TH & 7TH ADDITION	125	SCOTT	IA8215301	CWS	201001871	Coliform, Total (TCR)	30-Jun-10	MCL (TCR), Monthly	MCL	Compliance Achieved	2/22/2011
REVELLE 6TH & 7TH ADDITION	125	SCOTT	IA8215301	CWS	201002231	Coliform, Total (TCR)	31-Jul-10	MCL (TCR), Monthly	MCL	Compliance Achieved	2/22/2011
REVELLE 6TH & 7TH ADDITION	125	SCOTT	IA8215301	CWS	201006460	Coliform, Total (TCR)	31-Aug-10	MCL (TCR), Monthly	MCL	Compliance Achieved	2/22/2011
RHODYS	42	DUBUQUE	IA3126203	TNC	201002071	Nitrate (as N)	30-Jun-10	Monitoring (Chem-Rad), Routine Major	MON	Compliance Achieved	8/10/2010
RIVER OAKS DEVELOPMENT	200	DALLAS	IA2570302	CWS	201001931	Fecal Coliform	31-Jul-10	MCL (TCR), Acute	MCL	Compliance Achieved	8/25/2010
RIVER OAKS DEVELOPMENT	200	DALLAS	IA2570302	CWS	201001934	Fecal Coliform	31-Jul-10	MCL (TCR), Acute	MCL	Compliance Achieved	8/25/2010
RIVER OAKS DEVELOPMENT	200	DALLAS	IA2570302	CWS	201001935	Coliform, Total (TCR)	31-Jul-10	MCL (TCR), Monthly	MCL	Compliance Achieved	8/25/2010
RIVER OAKS DEVELOPMENT	200	DALLAS	IA2570302	CWS	201001951	Coliform, Total (TCR)	31-Jul-10	MCL (TCR), Monthly	MCL	Compliance Achieved	8/25/2010
RIVERSIDE LUTHERAN BIBLE CAMP	71	HAMILTON	IA8584401	NTNC	201006748	Coliform, Total (TCR)	31-Aug-10	Monitoring (TCR), Routine Major	MON	Compliance Achieved	9/13/2010
RIVERTON WATER WORKS	304	FREMONT	IA3655071	CWS	201001297	Uranium	31-Mar-10	MCL (Chem-Rad), Average	MCL	Compliance Achieved	6/28/2010
RIVERTON WATER WORKS	304	FREMONT	IA3655071	CWS	201100151	Coliform, Total (TCR)	30-Sep-10	Monitoring (TCR), Routine Major	MON	Compliance Achieved	10/20/2010
RIVERTON WATER WORKS	304	FREMONT	IA3655071	CWS	201107098	Chlorine	30-Sep-10	Monitoring (DBP), Major	MON	NOV Issued	11/15/2010
RIVERTON WATER WORKS	304	FREMONT	IA3655071	CWS	201107207	Coliform, Total (TCR)	30-Nov-10	Monitoring (TCR), Routine Major	MON	Compliance Achieved	12/14/2010

Name of the Public Water Supply (Alphabetical Listing)	Minimum Population Served	County	PWSID	PWS Type	Violation Number	Analyte	Compliance End Date	Violation	Violation Type	Enforcement Action	Enforcement Action Date
RIVERVIEW ESTATES	108	JOHNSON	IA5200347	CWS	201001830	Coliform, Total (TCR)	30-Jun-10	MCL (TCR), Monthly	MCL	Compliance Achieved	1/31/2011
RIVERVIEW ESTATES	108	JOHNSON	IA5200347	CWS	201001957	Coliform, Total (TCR)	31-Jul-10	MCL (TCR), Monthly	MCL	Compliance Achieved	1/31/2011
RIVERVIEW SUBDIVISION	37	MUSCATINE	IA7038301	CWS	201001879	Coliform, Total (TCR)	30-Jun-10	MCL (TCR), Monthly	MCL	Compliance Achieved	9/28/2010
RIVERVIEW SUBDIVISION	37	MUSCATINE	IA7038301	CWS	201002212	Coliform, Total (TCR)	31-Jul-10	MCL (TCR), Monthly	MCL	Compliance Achieved	9/28/2010
RIVERVIEW SUBDIVISION	37	MUSCATINE	IA7038301	CWS	201006638	Coliform, Total (TCR)	31-Aug-10	Monitoring (TCR), Routine Major	MON	Compliance Achieved	9/28/2010
ROCKY KNOLL MHP	65	WINNEBAGO	IA9525601	CWS	201100217	Nitrate (as N)	30-Sep-10	Monitoring (Chem-Rad), Routine Major	MON	Compliance Achieved	11/10/2010
ROLFE GOLF CLUB	31	POCAHONTAS	IA7639841	TNC	201001889	Fecal Coliform	30-Jun-10	MCL (TCR), Acute	MCL	Compliance Achieved	7/27/2010
ROLFE GOLF CLUB	31	POCAHONTAS	IA7639841	TNC	201001890	Coliform, Total (TCR)	30-Jun-10	MCL (TCR), Monthly	MCL	Compliance Achieved	7/27/2010
ROLLING ACRES GOLF COURSE	50	LINN	IA5718202	TNC	201001630	Coliform, Total (TCR)	31-May-10	MCL (TCR), Monthly	MCL	Compliance Achieved	10/25/2010
ROLLING ACRES GOLF COURSE	50	LINN	IA5718202	TNC	201006404	Coliform, Total (TCR)	31-Jul-10	Monitoring (TCR), Routine Major	MON	Compliance Achieved	10/25/2010
ROLLING ACRES GOLF COURSE	50	LINN	IA5718202	TNC	201006764	Coliform, Total (TCR)	31-Aug-10	Monitoring (TCR), Routine Major	MON	Compliance Achieved	10/25/2010
ROLLING ACRES GOLF COURSE	50	LINN	IA5718202	TNC	201100249	Coliform, Total (TCR)	30-Sep-10	Monitoring (TCR), Routine Major	MON	Compliance Achieved	10/25/2010
ROLLING ACRES GOLF COURSE	50	LINN	IA5718202	TNC	201100250	Nitrate (as N)	30-Sep-10	Monitoring (Chem-Rad), Routine Major	MON	NOV Issued	10/18/2010
ROLLING ACRES GOLF COURSE	50	LINN	IA5718202	TNC	201107418	Nitrate (as N)	31-Dec-10	Monitoring (Chem-Rad), Routine Major	MON	NOV Issued	1/19/2011
ROLLING ACRES SUBDIVISION	115	MUSCATINE	IA7048310	CWS	201107044	Copper	30-Sep-10	Routine/Repeat Tap Sampling (Pb/Cu)	MON	BCA Signed	1/10/2011
ROLLING ACRES SUBDIVISION	115	MUSCATINE	IA7048310	CWS	201107045	Lead	30-Sep-10	Routine/Repeat Tap Sampling (Pb/Cu)	MON	BCA Signed	1/10/2011

Name of the Public Water Supply (Alphabetical Listing)	Minimum Population Served	County	PWSID	PWS Type	Violation Number	Analyte	Compliance End Date	Violation	Violation Type	Enforcement Action	Enforcement Action Date
ROLLING GREEN ESTATES HOA INC	51	SCOTT	IA8225301	CWS	201001877	Coliform, Total (TCR)	30-Jun-10	MCL (TCR), Monthly	MCL	Compliance Achieved	8/26/2010
ROLLING GREEN ESTATES HOA INC	51	SCOTT	IA8225301	CWS	201002158	Coliform, Total (TCR)	05-Jun-10	Monitoring (GWR), Source Major	MON	Compliance Achieved	6/29/2010
ROLLING GREEN ESTATES HOA INC	51	SCOTT	IA8225301	CWS	201002225	Coliform, Total (TCR)	31-Jul-10	MCL (TCR), Monthly	MCL	Compliance Achieved	8/26/2010
ROLLING GREEN ESTATES HOA INC	51	SCOTT	IA8225301	CWS	201006421	Coliform, Total (TCR)	11-Jul-10	Monitoring (GWR), Source Major	MON	Compliance Achieved	8/26/2010
ROYAL OAKS SUBDIVISION	107	JOHNSON	IA5282303	CWS	201001863	Coliform, Total (TCR)	30-Jun-10	MCL (TCR), Monthly	MCL	Compliance Achieved	1/24/2011
RUDD WATERWORKS	369	FLOYD	IA3440007	CWS	201001227	Coliform, Total (TCR)	28-Feb-10	Monitoring (TCR), Routine Major	MON	Compliance Achieved	3/1/2010
RUDD WATERWORKS	369	FLOYD	IA3440007	CWS	201001252	Chlorine	28-Feb-10	Monitoring (DBP), Major	MON	Compliance Achieved	4/5/2010
RURAL WATER SYSTEM #1	3175	SIOUX	IA8400722	CWS	201006870	Failure to Obtain a Construction Permit	30-Sep-10	Construction Without Permit	STA	Compliance Achieved	4/14/2011
RUTHVEN WATER SUPPLY	860	PALO ALTO	IA7465010	CWS	201006869	Failure to meet Certified Operator Requirement	16-Sep-10	Certified Operator Requirement	STA	NOV Issued	9/16/2010
SADDLE BRONC	52	MUSCATINE	IA7016204	TNC	201100251	Nitrate (as N)	30-Sep-10	Monitoring (Chem-Rad), Routine Major	MON	Compliance Achieved	10/7/2010
SAINT JOSEPHS CHURCH	27	JOHNSON	IA5221801	TNC	201002270	Nitrate (as N)	30-Sep-10	MCL (Chem-Rad), Single Sample	MCL	Compliance Achieved	4/6/2011
SAINT JOSEPHS CHURCH	27	JOHNSON	IA5221801	TNC	201100237	Nitrate (as N)	30-Sep-10	Monitoring (Chem-Rad), Routine Major	MON	Compliance Achieved	10/7/2010
SAINT JOSEPHS CHURCH	27	JOHNSON	IA5221801	TNC	201107233	Nitrate (as N)	30-Nov-10	Monitoring (Chem-Rad), Routine Major	MON	Compliance Achieved	1/10/2011
SAINT JOSEPHS CHURCH	27	JOHNSON	IA5221801	TNC	201107411	Nitrate (as N)	31-Dec-10	Monitoring (Chem-Rad), Routine Major	MON	Compliance Achieved	1/10/2011
SALIX WATER SUPPLY	368	WOODBURY	IA9770024	CWS	201006873	Failure to meet Certified Operator Requirement	07-Oct-10	Certified Operator Requirement	STA	NOV Issued	10/7/2010
SCALES POINTE	71	JOHNSON	IA5200830	TNC	201001812	Coliform, Total (TCR)	30-Jun-10	MCL (TCR), Monthly	MCL	Compliance Achieved	8/3/2010

Name of the Public Water Supply (Alphabetical Listing)	Minimum Population Served	County	PWSID	PWS Type	Violation Number	Analyte	Compliance End Date	Violation	Violation Type	Enforcement Action	Enforcement Action Date
SCALES POINTE	71	JOHNSON	IA5200830	TNC	201006320	Coliform, Total (TCR)	31-Jul-10	Monitoring (TCR), Repeat Major	MON	Compliance Achieved	6/28/2010
SCALES POINTE	71	JOHNSON	IA5200830	TNC	201006422	Coliform, Total (TCR)	29-Jul-10	Monitoring (GWR), Source Major	MON	Compliance Achieved	6/28/2010
SCENIC VIEW CAMPGROUND	25	ALLAMAKEE	IA0385401	TNC	201100240	Coliform, Total (TCR)	30-Sep-10	Monitoring (TCR), Routine Major	MON	Compliance Achieved	4/28/2011
SCENIC VIEW CAMPGROUND	25	ALLAMAKEE	IA0385401	TNC	201107046	Coliform, Total (TCR)	31-Oct-10	Monitoring (TCR), Routine Major	MON	Compliance Achieved	4/28/2011
SCHALLER WATER SUPPLY	787	SAC	IA8156028	CWS	201002175	Nitrite (as N)	31-Jul-10	MCL (Chem-Rad), Single Sample	MCL	Compliance Achieved	1/13/2011
SCHALLER WATER SUPPLY	787	SAC	IA8156028	CWS	201002275	Nitrite (as N)	31-Aug-10	MCL (Chem-Rad), Single Sample	MCL	Compliance Achieved	1/13/2011
SCOOTERS	55	JONES	IA5307202	TNC	201100253	Coliform, Total (TCR)	30-Sep-10	Monitoring (TCR), Routine Major	MON	Compliance Achieved	10/22/2010
SCOTT CO PK - WEST LAKE-PARK TERRACE	150	SCOTT	IA8251901	TNC	201002109	Nitrate (as N)	30-Jun-10	Monitoring (Chem-Rad), Routine Major	MON	Compliance Achieved	8/4/2010
SCOTT CO-BUFFALO SHORES	150	SCOTT	IA8251903	TNC	201002110	Nitrate (as N)	30-Jun-10	Monitoring (Chem-Rad), Routine Major	MON	Compliance Achieved	8/4/2010
SCOTT CO-WEST LAKE LAKEVIEW	100	SCOTT	IA8215900	TNC	201002107	Nitrate (as N)	30-Jun-10	Monitoring (Chem-Rad), Routine Major	MON	Compliance Achieved	8/4/2010
SCOTT CO-WEST LAKE SUMMIT CAMPGROUND	150	SCOTT	IA8251900	TNC	201002108	Nitrate (as N)	30-Jun-10	Monitoring (Chem-Rad), Routine Major	MON	Compliance Achieved	8/4/2010
SCRANTON WATER SYSTEM	557	GREENE	IA3759031	CWS	201001100	Coliform, Total (TCR)	31-Jan-10	Monitoring (TCR), Routine Major	MON	Compliance Achieved	2/17/2010
SCRANTON WATER SYSTEM	557	GREENE	IA3759031	CWS	201001149	Chlorine	31-Jan-10	Record Keeping	RPT	Compliance Achieved	2/17/2010
SENTRAL COMMUNITY SCHOOL	478	KOSSUTH	IA5515527	NTNC	201107002	p-Dichlorobenzene	30-Sep-10	Monitoring (Chem-Rad), Routine Major	MON	Compliance Achieved	12/14/2010
SENTRAL COMMUNITY SCHOOL	478	KOSSUTH	IA5515527	NTNC	201107003	Di(2-Ethylhexyl) Phthalate	30-Sep-10	Monitoring (Chem-Rad), Routine Major	MON	Compliance Achieved	12/14/2010
SHAWVER WELL CO	28	CHICKASAW	IA1940301	NTNC	201100261	Coliform, Total (TCR)	30-Sep-10	Monitoring (TCR), Routine Major	MON	Compliance Achieved	10/13/2010

Name of the Public Water Supply (Alphabetical Listing)	Minimum Population Served	County	PWSID	PWS Type	Violation Number	Analyte	Compliance End Date	Violation	Violation Type	Enforcement Action	Enforcement Action Date
SHEFFIELD WATER SUPPLY	1172	FRANKLIN	IA3570037	CWS	201002254	Copper	30-Jun-10	AL (Pb/Cu), 90th Percentile	MCL	Lead/Copper DEEM	5/5/2011
SHELBY WATER SUPPLY	651	SHELBY	IA8369038	CWS	201100195	Coliform, Total (TCR)	30-Sep-10	Monitoring (TCR), Routine Major	MON	Compliance Achieved	10/25/2010
SHOP N GO	67	WOODBURY	IA9780203	TNC	201100260	Coliform, Total (TCR)	30-Sep-10	Monitoring (TCR), Routine Major	MON	Compliance Achieved	12/2/2010
SIEMENS ENERGY INC	450	LEE	IA5625146	NTNC	201002096	Nitrate (as N)	30-Jun-10	Monitoring (Chem-Rad), Routine Major	MON	Compliance Achieved	7/12/2010
SIOUX CITY WATER SUPPLY	85088	WOODBURY	IA9778054	CWS	201006879	Failure to Obtain a Construction Permit	03-Aug-10	Construction Without Permit	STA	NOV Issued	8/3/2010
SIRWA - CORNING/BROOKS	2049	ADAMS	IA0207704	CWS	201001464	Failure to meet Compliance Schedule	04-May-10	Compliance Schedule	V/E	NOV Issued	5/4/2010
SIRWA #1 (GREENFIELD)	1840	ADAIR	IA0140701	CWS	201001462	Failure to meet Compliance Schedule	04-May-10	Compliance Schedule	V/E	NOV Issued	5/4/2010
SIRWA #2 (CRESTON)	18318	UNION	IA8080701	CWS	201001463	Failure to meet Compliance Schedule	04-May-10	Compliance Schedule	V/E	NOV Issued	5/4/2010
SLATER MUNI WATER DEPT	1306	STORY	IA8580057	CWS	201002002	Copper	30-Jun-10	AL (Pb/Cu), 90th Percentile	MCL	BCA Signed	10/25/2010
SLEEPY HOLLOW CAMPGROUND & RV PARK	70	JOHNSON	IA5260601	CWS	201001057	Gross Alpha, excluding Rn & U	31-Mar-10	MCL (Chem-Rad), Average	MCL	BCA Signed	11/19/2009
SLEEPY HOLLOW CAMPGROUND & RV PARK	70	JOHNSON	IA5260601	CWS	201001619	Gross Alpha, excluding Rn & U	30-Jun-10	MCL (Chem-Rad), Average	MCL	BCA Signed	11/19/2009
SLEEPY HOLLOW CAMPGROUND & RV PARK	70	JOHNSON	IA5260601	CWS	201006362	Di(2-Ethylhexyl) Phthalate	31-Mar-10	Monitoring (Chem-Rad), Routine Major	MON	Compliance Achieved	3/14/2011
SLEEPY HOLLOW CAMPGROUND & RV PARK	70	JOHNSON	IA5260601	CWS	201006459	Gross Alpha, excluding Rn & U	30-Sep-10	MCL (Chem-Rad), Average	MCL	BCA Signed	11/19/2009
SLEEPY HOLLOW CAMPGROUND & RV PARK	70	JOHNSON	IA5260601	CWS	201006558	Gross Alpha, excluding Rn & U	30-Sep-10	Compliance Schedule	V/E	BCA Signed	11/19/2009
SLEEPY HOLLOW CAMPGROUND & RV PARK	70	JOHNSON	IA5260601	CWS	201006565	Coliform, Total (TCR)	30-Sep-10	MCL (TCR), Monthly	MCL	Compliance Achieved	4/11/2011
SLEEPY HOLLOW CAMPGROUND & RV PARK	70	JOHNSON	IA5260601	CWS	201100017	Fecal Coliform	31-Oct-10	MCL (TCR), Acute	MCL	Compliance Achieved	4/11/2011

Name of the Public Water Supply (Alphabetical Listing)	Minimum Population Served	County	PWSID	PWS Type	Violation Number	Analyte	Compliance End Date	Violation	Violation Type	Enforcement Action	Enforcement Action Date
SLEEPY HOLLOW CAMPGROUND & RV PARK	70	JOHNSON	IA5260601	CWS	201100018	Coliform, Total (TCR)	31-Oct-10	MCL (TCR), Monthly	MCL	Compliance Achieved	4/11/2011
SLEEPY HOLLOW CAMPGROUND & RV PARK	70	JOHNSON	IA5260601	CWS	201107145	Gross Alpha, excluding Rn & U	31-Dec-10	MCL (Chem-Rad), Average	MCL	BCA Signed	11/19/2009
SMITH LAKE PARK	55	KOSSUTH	IA5510901	TNC	201002041	Coliform, Total (TCR)	30-Jun-10	Monitoring (TCR), Routine Major	MON	Compliance Achieved	7/28/2010
SOME PLACE BAR & GRILL	30	CLAYTON	IA2268785	TNC	201001361	Nitrate (as N)	31-Mar-10	Monitoring (Chem-Rad), Routine Major	MON	Compliance Achieved	4/27/2010
SOUTH ENGLISH WATER SUPPLY	213	KEOKUK	IA5478074	CWS	201001381	Nitrate (as N)	31-Mar-10	Monitoring (Chem-Rad), Routine Major	MON	Compliance Achieved	5/17/2010
SOUTH ENGLISH WATER SUPPLY	213	KEOKUK	IA5478074	CWS	201001540	Gross Alpha, excluding Rn & U	31-Mar-10	Monitoring (Chem-Rad), Routine Major	MON	Compliance Achieved	6/7/2010
SOUTH HIGH POINT WELL ASSN 2	26	JOHNSON	IA5200324	CWS	201001285	Radium, Combined (226, 228)	31-Mar-10	MCL (Chem-Rad), Average	MCL	Compliance Achieved	2/13/2011
SOUTH HIGH POINT WELL ASSN 2	26	JOHNSON	IA5200324	CWS	201001472	Radium, Combined (226, 228)	30-Jun-10	MCL (Chem-Rad), Average	MCL	Compliance Achieved	2/13/2011
SOUTH HIGH POINT WELL ASSN 2	26	JOHNSON	IA5200324	CWS	201006871	Radium, Combined (226, 228)	30-Sep-10	Compliance Schedule	V/E	Compliance Achieved	2/13/2011
SOUTH WINN GOLF CLUB	218	WINNESHIEK	IA9615867	TNC	201001918	Coliform, Total (TCR)	30-Sep-10	MCL (TCR), Monthly	MCL	Compliance Achieved	11/17/2010
SOUTH WINN GOLF CLUB	218	WINNESHIEK	IA9615867	TNC	201100020	Coliform, Total (TCR)	31-Dec-10	MCL (TCR), Monthly	MCL	Compliance Achieved	11/17/2010
SOUTHEAST POLK RWD	6050	POLK	IA7774701	CWS	201006438	Chlorine	31-Jul-10	Record Keeping	RPT	NOV Issued	8/10/2010
SOUTHERN SIOUX COUNTY RURAL WATER	4542	SIOUX	IA8400733	CWS	201006235	Coliform, Total (TCR)	31-Aug-10	MCL (TCR), Monthly	MCL	Compliance Achieved	9/21/2010
SOUTHPARK	39	HARDIN	IA4260601	CWS	201107094	Arsenic	31-Dec-10	MCL (Chem-Rad), Single Sample	MCL	BCA Signed	11/23/2010
SOUTHWEST REG WATER DISTRICT (CLARINDA)	2092	PAGE	IA7383901	CWS	201001682	Total Haloacetic Acids (HAA5)	31-Mar-10	MCL (Chem-Rad), Average	MCL	Compliance Achieved	5/18/2010
SPARBOE AGRICULTURAL CORPORATION	30	HANCOCK	IA4103801	NTNC	201001899	Coliform, Total (TCR)	30-Sep-10	MCL (TCR), Monthly	MCL	Compliance Achieved	8/12/2010

Name of the Public Water Supply (Alphabetical Listing)	Minimum Population Served	County	PWSID	PWS Type	Violation Number	Analyte	Compliance End Date	Violation	Violation Type	Enforcement Action	Enforcement Action Date
SPARBOE FARMS (EGG BREAKING)	50	WRIGHT	IA9926802	NTNC	201100241	Total Haloacetic Acids (HAA5)	31-Aug-10	Monitoring (DBP), Major	MON	BCA Signed	11/2/2010
SPARBOE FARMS (EGG BREAKING)	50	WRIGHT	IA9926802	NTNC	201100242	Total Trihalomethanes (TTHM)	31-Aug-10	Monitoring (Chem-Rad), Routine Major	MON	BCA Signed	11/2/2010
SPARBOE FARMS (GOODELL)	30	HANCOCK	IA4135801	NTNC	201001406	Coliform, Total (TCR)	31-Mar-10	Monitoring (TCR), Routine Major	MON	Compliance Achieved	4/19/2010
SPARBOE FARMS INC	34	WEBSTER	IA4641163	NTNC	201100061	Coliform, Total (TCR)	30-Sep-10	Monitoring (TCR), Routine Major	MON	Compliance Achieved	10/7/2010
SPRINGBROOK STATE PARK-MAIN SYSTEM	67	GUTHRIE	IA3937934	TNC	201001230	Coliform, Total (TCR)	28-Feb-10	Monitoring (TCR), Routine Major	MON	Compliance Achieved	3/2/2010
SPRINGBROOK STATE PARK-MAIN SYSTEM	67	GUTHRIE	IA3937934	TNC	201006319	Coliform, Total (TCR)	31-Jul-10	Monitoring (TCR), Repeat Major	MON	Compliance Achieved	8/28/2010
SPRINGBROOK STATE PARK-MAIN SYSTEM	67	GUTHRIE	IA3937934	TNC	201006409	Coliform, Total (TCR)	26-Jul-10	Monitoring (GWR), Source Major	MON	Compliance Achieved	8/28/2010
ST JOHNS LUTHERAN CHURCH	157	JONES	IA5343815	NTNC	201001938	Coliform, Total (TCR)	31-Jul-10	MCL (TCR), Monthly	MCL	Compliance Achieved	5/25/2011
ST JOHNS LUTHERAN CHURCH	157	JONES	IA5343815	NTNC	201002273	Coliform, Total (TCR)	31-Aug-10	MCL (TCR), Monthly	MCL	Compliance Achieved	5/25/2011
ST JOHNS LUTHERAN CHURCH	157	JONES	IA5343815	NTNC	201006645	Coliform, Total (TCR)	31-Aug-10	Monitoring (TCR), Repeat Major	MON	Compliance Achieved	9/20/2010
ST JOHNS LUTHERAN CHURCH	157	JONES	IA5343815	NTNC	201006844	Coliform, Total (TCR)	30-Sep-10	MCL (TCR), Monthly	MCL	Compliance Achieved	5/25/2011
ST JOHNS LUTHERAN CHURCH	157	JONES	IA5343815	NTNC	201100022	Coliform, Total (TCR)	31-Oct-10	MCL (TCR), Monthly	MCL	Compliance Achieved	5/25/2011
ST JOHNS LUTHERAN CHURCH	157	JONES	IA5343815	NTNC	201107078	Coliform, Total (TCR)	30-Nov-10	MCL (TCR), Monthly	MCL	Compliance Achieved	5/25/2011
ST JOHNS LUTHERAN CHURCH	157	JONES	IA5343815	NTNC	201107155	Coliform, Total (TCR)	30-Nov-10	Monitoring (TCR), Repeat Major	MON	Compliance Achieved	5/25/2011
ST JOHNS LUTHERAN CHURCH	157	JONES	IA5343815	NTNC	201107267	Coliform, Total (TCR)	31-Dec-10	MCL (TCR), Monthly	MCL	Compliance Achieved	5/25/2011
ST JOHNS LUTHERAN CHURCH	29	BUTLER	IA1253853	TNC	201107329	Coliform, Total (TCR)	31-Dec-10	Monitoring (TCR), Routine Major	MON	Compliance Achieved	1/4/2011

Name of the Public Water Supply (Alphabetical Listing)	Minimum Population Served	County	PWSID	PWS Type	Violation Number	Analyte	Compliance End Date	Violation	Violation Type	Enforcement Action	Enforcement Action Date
ST JOHNS LUTHERAN CHURCH	157	JONES	IA5343815	NTNC	201108159	Coliform, Total (TCR)	31-Dec-10	Compliance Schedule	V/E	Compliance Achieved	5/25/2011
ST JOHNS LUTHERAN CHURCH (HAMPTON)	47	FRANKLIN	IA3544801	TNC	201001273	Coliform, Total (TCR)	31-Mar-10	MCL (TCR), Monthly	MCL	Compliance Achieved	9/27/2010
ST JOHNS LUTHERAN CHURCH (HAMPTON)	47	FRANKLIN	IA3544801	TNC	201001493	Coliform, Total (TCR)	28-Apr-10	Public Notice Rule Linked to Violation	PN	Compliance Achieved	6/1/2010
ST PAULS EVANGELICAL COUNTRY CHURCH	178	POTTAWATTAMIE	IA7820802	TNC	201107167	Coliform, Total (TCR)	30-Nov-10	Monitoring (TCR), Routine Major	MON	Compliance Achieved	1/3/2011
ST PETERS RECTORY	180	MITCHELL	IA6653801	TNC	201002202	Fecal Coliform	31-Jul-10	MCL (TCR), Acute	MCL	Compliance Achieved	9/27/2010
ST PETERS RECTORY	180	MITCHELL	IA6653801	TNC	201002203	Coliform, Total (TCR)	31-Jul-10	MCL (TCR), Monthly	MCL	Compliance Achieved	9/27/2010
ST PETERS RECTORY	180	MITCHELL	IA6653801	TNC	201006241	Coliform, Total (TCR)	31-Aug-10	MCL (TCR), Monthly	MCL	Compliance Achieved	9/27/2010
ST PETERS RECTORY	180	MITCHELL	IA6653801	TNC	201006635	Coliform, Total (TCR)	31-Aug-10	Monitoring (TCR), Repeat Major	MON	Compliance Achieved	9/1/2010
ST PETERS RECTORY	180	MITCHELL	IA6653801	TNC	201006786	Coliform, Total (TCR)	23-Aug-10	Monitoring (GWR), Source Major	MON	Compliance Achieved	9/1/2010
STERLING WOODS ASSOCIATION	38	SCOTT	IA8209306	CWS	201001647	Coliform, Total (TCR)	30-Jun-10	MCL (TCR), Monthly	MCL	Compliance Achieved	2/8/2011
STERLING WOODS ASSOCIATION	38	SCOTT	IA8209306	CWS	201001955	Coliform, Total (TCR)	31-Jul-10	MCL (TCR), Monthly	MCL	Compliance Achieved	2/8/2011
STERLING WOODS ASSOCIATION	38	SCOTT	IA8209306	CWS	201006453	Coliform, Total (TCR)	31-Aug-10	MCL (TCR), Monthly	MCL	Compliance Achieved	2/8/2011
STERLING WOODS ASSOCIATION	38	SCOTT	IA8209306	CWS	201006838	Coliform, Total (TCR)	30-Sep-10	MCL (TCR), Monthly	MCL	Compliance Achieved	2/8/2011
STONE CREEK NORTH	50	SCOTT	IA8271302	CWS	201107288	Copper	30-Sep-10	AL (Pb/Cu), 90th Percentile	MCL	NOV Issued	1/11/2011
STORY CITY WATER DEPT	3228	STORY	IA8584000	CWS	201001806	Lead	30-Jun-10	AL (Pb/Cu), 90th Percentile	MCL	BCA Signed	11/16/2010
SUMNER WATER SUPPLY	2028	BREMER	IA0970006	CWS	201100116	Total Trihalomethanes (TTHM)	31-Aug-10	Monitoring (Chem-Rad), Routine Major	MON	NOV Issued	10/18/2010

Name of the Public Water Supply (Alphabetical Listing)	Minimum Population Served	County	PWSID	PWS Type	Violation Number	Analyte	Compliance End Date	Violation	Violation Type	Enforcement Action	Enforcement Action Date
SUMNER WATER SUPPLY	2028	BREMER	IA0970006	CWS	201100117	Total Haloacetic Acids (HAA5)	31-Aug-10	Monitoring (DBP), Major	MON	NOV Issued	10/18/2010
SUNNY BRAE GOLF & COUNTRY CLUB	63	MITCHELL	IA6663201	TNC	201001257	Nitrate (as N)	23-Jan-10	Public Notice Rule Linked to Violation	PN	NOV Issued	3/16/2010
SUNNY BRAE GOLF & COUNTRY CLUB	63	MITCHELL	IA6663201	TNC	201107382	Coliform, Total (TCR)	31-Dec-10	Monitoring (TCR), Routine Major	MON	Compliance Achieved	2/9/2011
SUPER 20 MOBILE HOME PARK	236	DUBUQUE	IA3126603	CWS	201001051	Failure to meet Certified Operator Requirement	08-Feb-10	Certified Operator Requirement	STA	Compliance Achieved	3/29/2010
SUPER 20 MOBILE HOME PARK	236	DUBUQUE	IA3126603	CWS	201006749	Coliform, Total (TCR)	31-Aug-10	Monitoring (TCR), Routine Major	MON	Compliance Achieved	10/10/2010
SUTHERLAND WATER SUPPLY	718	O'BRIEN	IA7177007	CWS	201107225	Coliform, Total (TCR)	30-Nov-10	Monitoring (TCR), Routine Major	MON	Compliance Achieved	12/8/2010
SWAN WATER WORKS	121	MARION	IA6380047	CWS	201001046	Chlorine	28-Feb-10	Monitoring (DBP), Major	MON	Compliance Achieved	7/14/2010
SWEENEYS	113	DUBUQUE	IA3126732	TNC	201006831	Coliform, Total (TCR)	30-Sep-10	MCL (TCR), Monthly	MCL	Compliance Achieved	11/5/2010
SWEENEYS	113	DUBUQUE	IA3126732	TNC	201100013	Coliform, Total (TCR)	31-Dec-10	MCL (TCR), Monthly	MCL	Compliance Achieved	11/5/2010
SYNGENTA SEEDS INC	25	CARROLL	IA1415101	NTNC	201006552	Arsenic	30-Jun-10	MCL (Chem-Rad), Single Sample	MCL	NOV Issued	9/3/2010
SYNGENTA SEEDS INC	58	JOHNSON	IA5240101	NTNC	201006577	Copper	30-Sep-10	AL (Pb/Cu), 90th Percentile	MCL	Lead/Copper DEEM	2/15/2011
SYNGENTA SEEDS INC	58	JOHNSON	IA5240101	NTNC	201006578	Lead	30-Sep-10	AL (Pb/Cu), 90th Percentile	MCL	Lead/Copper DEEM	2/15/2011
SYNGENTA SEEDS INC	25	CARROLL	IA1415101	NTNC	201100030	Lead	30-Sep-10	AL (Pb/Cu), 90th Percentile	MCL	BCA Signed	10/15/2010
SYNGENTA SEEDS INC	58	JOHNSON	IA5240101	NTNC	201100162	Coliform, Total (TCR)	30-Sep-10	Monitoring (TCR), Routine Major	MON	Compliance Achieved	1/26/2011
SYNGENTA SEEDS INC	58	JOHNSON	IA5240101	NTNC	201107300	Iowa Administrative Code	31-Dec-10	Monitoring (MOR)	MON	Compliance Achieved	1/13/2011
SYNGENTA SEEDS INC	58	JOHNSON	IA5240101	NTNC	201107364	Coliform, Total (TCR)	31-Dec-10	Monitoring (TCR), Routine Major	MON	Compliance Achieved	1/26/2011

Name of the Public Water Supply (Alphabetical Listing)	Minimum Population Served	County	PWSID	PWS Type	Violation Number	Analyte	Compliance End Date	Violation	Violation Type	Enforcement Action	Enforcement Action Date
SYNGENTA SEEDS INC	58	JOHNSON	IA5240101	NTNC	201107365	Nitrate (as N)	31-Dec-10	Monitoring (Chem-Rad), Routine Major	MON	Compliance Achieved	2/8/2011
TERRIL MUNICIPAL WATERWORKS	406	DICKINSON	IA3080016	CWS	201006729	Coliform, Total (TCR)	31-Aug-10	Monitoring (TCR), Routine Major	MON	Compliance Achieved	9/7/2010
TERRIL MUNICIPAL WATERWORKS	406	DICKINSON	IA3080016	CWS	201006828	Chlorine	30-Sep-10	Monitoring (DBP), Major	MON	Compliance Achieved	12/6/2010
TERRY WATER ASSOCIATION	46	BENTON	IA0690303	CWS	201001014	Coliform, Total (TCR)	31-Jan-10	MCL (TCR), Monthly	MCL	Compliance Achieved	2/17/2010
TERRY WATER ASSOCIATION	46	BENTON	IA0690303	CWS	201001052	Failure to meet Certified Operator Requirement	08-Feb-10	Certified Operator Requirement	STA	Compliance Achieved	8/25/2010
TERRY WATER ASSOCIATION	46	BENTON	IA0690303	CWS	201006530	Failure to Issue Consumer Confidence Report	31-Jul-10	Consumer Confidence Report (CCR)	RPT	NOV Issued	8/31/2010
TESAHA	32	LINN	IA5776301	CWS	201107596	Copper	31-Dec-10	Routine/Repeat Tap Sampling (Pb/Cu)	MON	NOV Issued	2/25/2011
TESAHA	32	LINN	IA5776301	CWS	201107597	Lead	31-Dec-10	Routine/Repeat Tap Sampling (Pb/Cu)	MON	NOV Issued	2/25/2011
THE CATFISH PLACE	69	MUSCATINE	IA7052204	TNC	201001603	Nitrate (as N)	30-Apr-10	Monitoring (Chem-Rad), Routine Major	MON	Compliance Achieved	6/16/2010
THE CATFISH PLACE	69	MUSCATINE	IA7052204	TNC	201001771	Nitrate (as N)	31-May-10	Monitoring (Chem-Rad), Routine Major	MON	Compliance Achieved	6/16/2010
THE CATFISH PLACE	69	MUSCATINE	IA7052204	TNC	201006402	Nitrate (as N)	31-Jul-10	Monitoring (Chem-Rad), Routine Major	MON	Compliance Achieved	11/30/2010
THE CATFISH PLACE	69	MUSCATINE	IA7052204	TNC	201006762	Nitrate (as N)	31-Aug-10	Monitoring (Chem-Rad), Routine Major	MON	Compliance Achieved	11/30/2010
THE CATFISH PLACE	69	MUSCATINE	IA7052204	TNC	201100233	Nitrate (as N)	30-Sep-10	Monitoring (Chem-Rad), Routine Major	MON	Compliance Achieved	11/30/2010
THE CATFISH PLACE	69	MUSCATINE	IA7052204	TNC	201107040	Nitrate (as N)	31-Oct-10	Monitoring (Chem-Rad), Routine Major	MON	Compliance Achieved	11/30/2010
THE CATFISH PLACE	69	MUSCATINE	IA7052204	TNC	201107406	Nitrate (as N)	31-Dec-10	Monitoring (Chem-Rad), Routine Major	MON	Compliance Achieved	1/31/2011
THE CATFISH PLACE	69	MUSCATINE	IA7052204	TNC	201107449	Coliform, Total (TCR)	31-Dec-10	Monitoring (TCR), Routine Major	MON	Compliance Achieved	2/23/2011

Name of the Public Water Supply (Alphabetical Listing)	Minimum Population Served	County	PWSID	PWS Type	Violation Number	Analyte	Compliance End Date	Violation	Violation Type	Enforcement Action	Enforcement Action Date
THE DAM BAR & GRILL INC	29	LINN	IA5786890	TNC	201006656	Coliform, Total (TCR)	31-Aug-10	Monitoring (TCR), Routine Major	MON	Compliance Achieved	10/21/2010
THE DAM BAR & GRILL INC	29	LINN	IA5786890	TNC	201006717	Coliform, Total (TCR)	31-Aug-10	Monitoring (TCR), Repeat Major	MON	Compliance Achieved	10/21/2010
THE DAM BAR & GRILL INC	29	LINN	IA5786890	TNC	201006742	Coliform, Total (TCR)	31-Aug-10	Monitoring (TCR), Routine Major	MON	Compliance Achieved	10/21/2010
THE DAM BAR & GRILL INC	29	LINN	IA5786890	TNC	201006743	Nitrate (as N)	31-Aug-10	Monitoring (Chem-Rad), Routine Major	MON	Compliance Achieved	10/21/2010
THE DAM BAR & GRILL INC	29	LINN	IA5786890	TNC	201006744	Nitrate (as N)	31-Aug-10	Monitoring (Chem-Rad), Routine Major	MON	Compliance Achieved	10/21/2010
THE DAM BAR & GRILL INC	29	LINN	IA5786890	TNC	201006821	Coliform, Total (TCR)	21-Aug-10	Monitoring (GWR), Source Major	MON	Compliance Achieved	10/21/2010
THE DAM BAR & GRILL INC	29	LINN	IA5786890	TNC	201100177	Coliform, Total (TCR)	30-Sep-10	Monitoring (TCR), Routine Major	MON	Compliance Achieved	10/21/2010
THE DAM BAR & GRILL INC	29	LINN	IA5786890	TNC	201100178	Nitrate (as N)	30-Sep-10	Monitoring (Chem-Rad), Routine Major	MON	Compliance Achieved	10/21/2010
THE DAM BAR & GRILL INC	29	LINN	IA5786890	TNC	201100179	Nitrate (as N)	30-Sep-10	Monitoring (Chem-Rad), Routine Major	MON	Compliance Achieved	10/21/2010
THE DAM BAR & GRILL INC	29	LINN	IA5786890	TNC	201100180	Coliform, Total (TCR)	30-Sep-10	Monitoring (TCR), Routine Major	MON	Compliance Achieved	10/21/2010
THE DAM BAR & GRILL INC	29	LINN	IA5786890	TNC	201107220	Coliform, Total (TCR)	30-Nov-10	Monitoring (TCR), Routine Major	MON	Compliance Achieved	1/4/2011
THE DAM BAR & GRILL INC	29	LINN	IA5786890	TNC	201107221	Nitrate (as N)	30-Nov-10	Monitoring (Chem-Rad), Routine Major	MON	Compliance Achieved	1/4/2011
THE DAM BAR & GRILL INC	29	LINN	IA5786890	TNC	201107222	Coliform, Total (TCR)	30-Nov-10	Monitoring (TCR), Routine Major	MON	Compliance Achieved	1/4/2011
THE DAM BAR & GRILL INC	29	LINN	IA5786890	TNC	201107223	Nitrate (as N)	30-Nov-10	Monitoring (Chem-Rad), Routine Major	MON	Compliance Achieved	1/4/2011
THE DAM BAR & GRILL INC	29	LINN	IA5786890	TNC	201107375	Coliform, Total (TCR)	31-Dec-10	Monitoring (TCR), Routine Major	MON	Compliance Achieved	1/4/2011
THE DAM BAR & GRILL INC	29	LINN	IA5786890	TNC	201107376	Nitrate (as N)	31-Dec-10	Monitoring (Chem-Rad), Routine Major	MON	Compliance Achieved	1/4/2011

Name of the Public Water Supply (Alphabetical Listing)	Minimum Population Served	County	PWSID	PWS Type	Violation Number	Analyte	Compliance End Date	Violation	Violation Type	Enforcement Action	Enforcement Action Date
THE DAM BAR & GRILL INC	29	LINN	IA5786890	TNC	201107377	Nitrate (as N)	31-Dec-10	Monitoring (Chem-Rad), Routine Major	MON	Compliance Achieved	1/4/2011
THE DAM BAR & GRILL INC	29	LINN	IA5786890	TNC	201107378	Coliform, Total (TCR)	31-Dec-10	Monitoring (TCR), Routine Major	MON	Compliance Achieved	1/4/2011
THE DETOUR WATER SUPPLY	27	DELAWARE	IA3130201	TNC	201002123	Nitrate (as N)	30-Jun-10	Monitoring (Chem-Rad), Routine Major	MON	Compliance Achieved	2/7/2011
THE DETOUR WATER SUPPLY	27	DELAWARE	IA3130201	TNC	201006282	Coliform, Total (TCR)	31-Jul-10	Monitoring (TCR), Routine Major	MON	Compliance Achieved	10/12/2010
THE DETOUR WATER SUPPLY	27	DELAWARE	IA3130201	TNC	201107232	Coliform, Total (TCR)	30-Nov-10	Monitoring (TCR), Routine Major	MON	NOV Issued	12/15/2010
THE DETOUR WATER SUPPLY	27	DELAWARE	IA3130201	TNC	201107394	Nitrate (as N)	31-Dec-10	Monitoring (Chem-Rad), Routine Major	MON	Compliance Achieved	2/7/2011
THE DETOUR WATER SUPPLY	27	DELAWARE	IA3130201	TNC	201107395	Coliform, Total (TCR)	31-Dec-10	Monitoring (TCR), Routine Major	MON	NOV Issued	1/19/2011
THE HEIGHTS	59	JONES	IA5343202	TNC	201100164	Nitrate (as N)	30-Sep-10	Monitoring (Chem-Rad), Routine Major	MON	Compliance Achieved	10/6/2010
THE LEARNING JOURNEY	60	POTTAWATTAMIE	IA7820502	NTNC	201001140	Coliform, Total (TCR)	31-Jan-10	Monitoring (TCR), Routine Major	MON	Compliance Achieved	2/15/2010
THE MILE AWAY	25	POTTAWATTAMIE	IA7820203	TNC	201001399	Nitrate (as N)	31-Mar-10	Monitoring (Chem-Rad), Routine Major	MON	Compliance Achieved	5/5/2010
THE OLD STORE	38	WINNESHIEK	IA9644201	TNC	201001264	Nitrate (as N)	31-Mar-10	MCL (Chem-Rad), Single Sample	MCL	Compliance Achieved	8/21/2010
THE OLD WATERVILLE STORE	75	ALLAMAKEE	IA0397202	TNC	201001020	Coliform, Total (TCR)	31-Mar-10	MCL (TCR), Monthly	MCL	Compliance Achieved	2/15/2010
THE OLD WATERVILLE STORE	75	ALLAMAKEE	IA0397202	TNC	201001980	Fecal Coliform	30-Sep-10	MCL (TCR), Acute	MCL	Compliance Achieved	4/11/2011
THE OLD WATERVILLE STORE	75	ALLAMAKEE	IA0397202	TNC	201001981	Coliform, Total (TCR)	30-Sep-10	MCL (TCR), Monthly	MCL	Compliance Achieved	4/11/2011
THE OLD WATERVILLE STORE	75	ALLAMAKEE	IA0397202	TNC	201006283	Coliform, Total (TCR)	31-Jul-10	Monitoring (TCR), Repeat Major	MON	Compliance Achieved	10/18/2010
THE OLD WATERVILLE STORE	75	ALLAMAKEE	IA0397202	TNC	201106935	Coliform, Total (TCR)	31-Oct-10	Monitoring (TCR), Repeat Major	MON	Compliance Achieved	2/28/2011

Name of the Public Water Supply (Alphabetical Listing)	Minimum Population Served	County	PWSID	PWS Type	Violation Number	Analyte	Compliance End Date	Violation	Violation Type	Enforcement Action	Enforcement Action Date
THE OLD WATERVILLE STORE	75	ALLAMAKEE	IA0397202	TNC	201107059	Coliform, Total (TCR)	30-Oct-10	Monitoring (GWR), Source Major	MON	Compliance Achieved	2/28/2011
THE OLD WATERVILLE STORE	75	ALLAMAKEE	IA0397202	TNC	201107181	Coliform, Total (TCR)	30-Nov-10	Monitoring (TCR), Routine Major	MON	Compliance Achieved	2/28/2011
THE PINICON	187	CHICKASAW	IA1970203	TNC	201001300	Failure to meet Compliance Schedule	28-Feb-10	Compliance Schedule	V/E	BCA Signed	12/7/2009
THE PINICON	187	CHICKASAW	IA1970203	TNC	201001358	Nitrate (as N)	31-Mar-10	Monitoring (Chem-Rad), Routine Major	MON	Compliance Achieved	5/5/2010
THE PINICON	187	CHICKASAW	IA1970203	TNC	201001781	Coliform, Total (TCR)	30-May-10	Monitoring (GWR), Source Major	MON	Compliance Achieved	6/16/2010
THE PINICON	187	CHICKASAW	IA1970203	TNC	201002233	Coliform, Total (TCR)	31-Jul-10	MCL (TCR), Monthly	MCL	Compliance Achieved	10/28/2010
THE PINICON	187	CHICKASAW	IA1970203	TNC	201100278	Coliform, Total (TCR)	27-Sep-10	Monitoring (GWR), Source Major	MON	Compliance Achieved	10/12/2010
THE RED BARN RESORT	63	ALLAMAKEE	IA0300617	TNC	201001070	Coliform, Total (TCR)	31-Jan-10	Monitoring (TCR), Routine Major	MON	Compliance Achieved	2/8/2010
THE RED BARN RESORT	63	ALLAMAKEE	IA0300617	TNC	201002046	Nitrate (as N)	30-Jun-10	Monitoring (Chem-Rad), Routine Major	MON	Compliance Achieved	7/23/2010
THE WHARF	52	DUBUQUE	IA3126204	TNC	201001369	Coliform, Total (TCR)	31-Mar-10	Monitoring (TCR), Routine Major	MON	Compliance Achieved	6/30/2010
THE WHARF	52	DUBUQUE	IA3126204	TNC	201001721	Coliform, Total (TCR)	31-May-10	Monitoring (TCR), Repeat Major	MON	Compliance Achieved	6/30/2010
THE WHARF	52	DUBUQUE	IA3126204	TNC	201001779	Coliform, Total (TCR)	13-May-10	Monitoring (GWR), Source Major	MON	Compliance Achieved	7/29/2010
THE WHARF	52	DUBUQUE	IA3126204	TNC	201002072	Nitrate (as N)	30-Jun-10	Monitoring (Chem-Rad), Routine Major	MON	BCA Signed	6/9/2009
THE WHARF	52	DUBUQUE	IA3126204	TNC	201106974	Coliform, Total (TCR)	31-Oct-10	Monitoring (TCR), Routine Major	MON	Compliance Achieved	11/30/2010
THE WILDS RV & GOLF RESORT	58	FREMONT	IA3609201	TNC	201100252	Nitrate (as N)	30-Sep-10	Monitoring (Chem-Rad), Routine Major	MON	BCA Signed	5/12/2011
THE WILDS RV & GOLF RESORT	58	FREMONT	IA3609201	TNC	201100340	Coliform, Total (TCR)	31-Oct-10	MCL (TCR), Monthly	MCL	Compliance Achieved	5/3/2011

Name of the Public Water Supply (Alphabetical Listing)	Minimum Population Served	County	PWSID	PWS Type	Violation Number	Analyte	Compliance End Date	Violation	Violation Type	Enforcement Action	Enforcement Action Date
THE WILDS RV & GOLF RESORT	58	FREMONT	IA3609201	TNC	201107084	Coliform, Total (TCR)	30-Nov-10	MCL (TCR), Monthly	MCL	Compliance Achieved	5/3/2011
THE WILDS RV & GOLF RESORT	58	FREMONT	IA3609201	TNC	201107158	Coliform, Total (TCR)	30-Nov-10	Monitoring (TCR), Repeat Major	MON	Compliance Achieved	5/3/2011
THE WILDS RV & GOLF RESORT	58	FREMONT	IA3609201	TNC	201107173	Coliform, Total (TCR)	30-Nov-10	Monitoring (TCR), Repeat Major	MON	Compliance Achieved	5/3/2011
THE WILDS RV & GOLF RESORT	58	FREMONT	IA3609201	TNC	201107243	Coliform, Total (TCR)	28-Nov-10	Monitoring (GWR), Source Major	MON	Compliance Achieved	5/3/2011
THE WILDS RV & GOLF RESORT	58	FREMONT	IA3609201	TNC	201107247	Coliform, Total (TCR)	07-Nov-10	Monitoring (GWR), Source Major	MON	Compliance Achieved	5/3/2011
THE ZIPPER	35	WINNESHIEK	IA9637201	TNC	201001394	Coliform, Total (TCR)	31-Mar-10	Monitoring (TCR), Routine Major	MON	Compliance Achieved	6/7/2010
THE ZIPPER	35	WINNESHIEK	IA9637201	TNC	201100204	Nitrate (as N)	30-Sep-10	Monitoring (Chem-Rad), Routine Major	MON	Compliance Achieved	1/10/2011
THE ZIPPER	35	WINNESHIEK	IA9637201	TNC	201100205	Coliform, Total (TCR)	30-Sep-10	Monitoring (TCR), Routine Major	MON	Compliance Achieved	10/19/2010
THORPE PARK-WINNEBAGO CONSERVATION	60	WINNEBAGO	IA9525901	TNC	201001913	Coliform, Total (TCR)	31-Jul-10	MCL (TCR), Monthly	MCL	Compliance Achieved	8/11/2010
THREE ELMS GOLF COURSE	28	BUCHANAN	IA1037201	TNC	201002239	Coliform, Total (TCR)	31-Jul-10	MCL (TCR), Monthly	MCL	Compliance Achieved	9/22/2010
THREE ELMS GOLF COURSE	28	BUCHANAN	IA1037201	TNC	201006659	Coliform, Total (TCR)	31-Aug-10	Monitoring (TCR), Repeat Major	MON	Compliance Achieved	9/14/2010
TIMBER RIDGE	225	BENTON	IA0600600	CWS	201100113	Nitrite (as N)	30-Sep-10	Monitoring (Chem-Rad), Routine Major	MON	Compliance Achieved	10/20/2010
TIMBER VALLEY ESTATES (1ST & 2ND ADD)	192	SCOTT	IA8215384	CWS	201100187	Nitrate (as N)	30-Sep-10	Monitoring (Chem-Rad), Routine Major	MON	Compliance Achieved	11/17/2010
TIMBER VALLEY ESTATES (THIRD ADDITION)	65	SCOTT	IA8215385	CWS	201100188	Nitrate (as N)	30-Sep-10	Monitoring (Chem-Rad), Routine Major	MON	Compliance Achieved	11/17/2010
TIMBERLAKE	52	JOHNSON	IA5200810	CWS	201001301	Coliform, Total (TCR)	30-Apr-10	MCL (TCR), Monthly	MCL	Compliance Achieved	1/24/2011
TIMBERLAKE	52	JOHNSON	IA5200810	CWS	201002185	Coliform, Total (TCR)	31-Jul-10	MCL (TCR), Monthly	MCL	Compliance Achieved	1/24/2011

Name of the Public Water Supply (Alphabetical Listing)	Minimum Population Served	County	PWSID	PWS Type	Violation Number	Analyte	Compliance End Date	Violation	Violation Type	Enforcement Action	Enforcement Action Date
TIMBERLAKE	52	JOHNSON	IA5200810	CWS	201006521	Coliform, Total (TCR)	31-Aug-10	MCL (TCR), Monthly	MCL	Compliance Achieved	1/24/2011
TIMBERLAKE	52	JOHNSON	IA5200810	CWS	201100007	Coliform, Total (TCR)	30-Sep-10	MCL (TCR), Monthly	MCL	Compliance Achieved	1/24/2011
TIMBERLAKE	52	JOHNSON	IA5200810	CWS	201106889	Coliform, Total (TCR)	31-Oct-10	MCL (TCR), Monthly	MCL	Compliance Achieved	1/24/2011
TIMBERLAKE	52	JOHNSON	IA5200810	CWS	201107254	Coliform, Total (TCR)	31-Dec-10	MCL (TCR), Monthly	MCL	Compliance Achieved	1/24/2011
TOM BELL DETASSLING	50	MUSCATINE	IA7016801	TNC	201002146	Nitrate (as N)	30-Jun-10	Monitoring (Chem-Rad), Routine Major	MON	Compliance Achieved	7/12/2010
TRAEER GOLF & COUNTRY CLUB	42	TAMA	IA8681200	TNC	201001390	Nitrate (as N)	31-Mar-10	Monitoring (Chem-Rad), Routine Major	MON	Compliance Achieved	6/22/2010
TRI-CITY GOLF CLUB	26	CLAYTON	IA2254844	TNC	201100127	Nitrate (as N)	30-Sep-10	Monitoring (Chem-Rad), Routine Major	MON	Compliance Achieved	11/15/2010
TURKEY CREEK DEVELOPMENT	65	JOHNSON	IA5225316	CWS	201006540	Failure to Issue Consumer Confidence Report	01-Jul-10	Consumer Confidence Report (CCR)	RPT	Compliance Achieved	10/5/2010
TWIN COUNTY DAIRY INC	262	JOHNSON	IA5221102	TNC	201001313	Nitrite (as N)	30-Jun-10	MCL (Chem-Rad), Single Sample	MCL	Compliance Achieved	1/5/2011
TWIN COUNTY DAIRY INC	262	JOHNSON	IA5221102	TNC	201001775	Nitrite (as N)	31-May-10	Monitoring (Chem-Rad), Routine Major	MON	Compliance Achieved	6/15/2010
TWIN COUNTY DAIRY INC	262	JOHNSON	IA5221102	TNC	201006592	Nitrite (as N)	30-Sep-10	MCL (Chem-Rad), Single Sample	MCL	Compliance Achieved	1/5/2011
TWIN COUNTY DAIRY INC	262	JOHNSON	IA5221102	TNC	201107055	Nitrite (as N)	31-Oct-10	Monitoring (Chem-Rad), Routine Major	MON	Compliance Achieved	12/2/2010
TWIN KNOLLS FOURTH/FIFTH ADDITION	144	LINN	IA5784326	CWS	201001720	Coliform, Total (TCR)	31-May-10	Monitoring (TCR), Repeat Major	MON	Compliance Achieved	6/14/2010
TWIN PONDS WEST - CHICKASAW CCB	75	CHICKASAW	IA1970403	TNC	201001359	Coliform, Total (TCR)	31-Mar-10	Monitoring (TCR), Routine Major	MON	Compliance Achieved	5/27/2010
TWIN PONDS WEST - CHICKASAW CCB	75	CHICKASAW	IA1970403	TNC	201002217	Coliform, Total (TCR)	30-Sep-10	MCL (TCR), Monthly	MCL	Compliance Achieved	11/29/2010
TWIN PONDS WEST - CHICKASAW CCB	75	CHICKASAW	IA1970403	TNC	201006248	Coliform, Total (TCR)	31-Aug-10	MCL (TCR), Monthly	MCL	Compliance Achieved	11/29/2010

Name of the Public Water Supply (Alphabetical Listing)	Minimum Population Served	County	PWSID	PWS Type	Violation Number	Analyte	Compliance End Date	Violation	Violation Type	Enforcement Action	Enforcement Action Date
TWIN PONDS WEST - CHICKASAW CCB	75	CHICKASAW	IA1970403	TNC	201100312	Fecal Coliform	31-Dec-10	MCL (TCR), Acute	MCL	Compliance Achieved	11/29/2010
TWIN PONDS WEST - CHICKASAW CCB	75	CHICKASAW	IA1970403	TNC	201100313	Coliform, Total (TCR)	31-Dec-10	MCL (TCR), Monthly	MCL	Compliance Achieved	11/29/2010
TWIN PONDS WEST - CHICKASAW CCB	75	CHICKASAW	IA1970403	TNC	201107333	Coliform, Total (TCR)	31-Dec-10	Monitoring (TCR), Routine Major	MON	Compliance Achieved	1/27/2011
TWIN VALLEY LAKES IMPROVEMENT ASSN	100	JOHNSON	IA5200861	CWS	201001943	Coliform, Total (TCR)	31-Jul-10	MCL (TCR), Monthly	MCL	Compliance Achieved	1/26/2011
TYSON FOODS INC	100	BUCHANAN	IA1037101	NTNC	201001053	Failure to meet Certified Operator Requirement	08-Feb-10	Certified Operator Requirement	STA	Compliance Achieved	2/22/2010
UPPER IOWA RESORT & RENTAL	27	ALLAMAKEE	IA0300648	TNC	201100110	Coliform, Total (TCR)	30-Sep-10	Monitoring (TCR), Routine Major	MON	Compliance Achieved	5/17/2011
UPPER IOWA RESORT & RENTAL	27	ALLAMAKEE	IA0300648	TNC	201100111	Coliform, Total (TCR)	30-Sep-10	Monitoring (TCR), Routine Major	MON	Compliance Achieved	5/17/2011
UPPER MISS F&W REFUGE MCGREGOR DISTRICT	25	CLAYTON	IA2258901	TNC	201006339	Coliform, Total (TCR)	31-Jul-10	Monitoring (TCR), Routine Major	MON	Compliance Achieved	9/22/2010
UPPER MISS F&W REFUGE MCGREGOR DISTRICT	25	CLAYTON	IA2258901	TNC	201106969	Coliform, Total (TCR)	31-Oct-10	Monitoring (TCR), Routine Major	MON	Compliance Achieved	11/3/2010
VALLEY HIGH SCHOOL	675	FAYETTE	IA3338500	NTNC	201006734	Coliform, Total (TCR)	31-Aug-10	Monitoring (TCR), Routine Major	MON	Compliance Achieved	9/28/2010
VALLEY INN (PLEASANT VALLEY)	105	SCOTT	IA8271743	TNC	201002112	Coliform, Total (TCR)	30-Jun-10	Monitoring (TCR), Routine Major	MON	Compliance Achieved	8/2/2010
VALLEY INN (PLEASANT VALLEY)	105	SCOTT	IA8271743	TNC	201107388	Coliform, Total (TCR)	31-Dec-10	Monitoring (TCR), Routine Major	MON	Compliance Achieved	1/18/2011
VALLEY VIEW WATER ASSOCIATION	65	HARRISON	IA4300601	CWS	201001796	Fecal Coliform	30-Jun-10	MCL (TCR), Acute	MCL	Compliance Achieved	12/15/2010
VALLEY VIEW WATER ASSOCIATION	65	HARRISON	IA4300601	CWS	201001797	Coliform, Total (TCR)	30-Jun-10	MCL (TCR), Monthly	MCL	Compliance Achieved	12/15/2010
VERN ACRES (OLIPHANT ADDITION)	150	LINN	IA5784303	CWS	201001657	Coliform, Total (TCR)	30-Jun-10	MCL (TCR), Monthly	MCL	Compliance Achieved	12/20/2010
VERN ACRES (OLIPHANT ADDITION)	150	LINN	IA5784303	CWS	201002165	Coliform, Total (TCR)	20-Jun-10	Monitoring (GWR), Source Major	MON	Compliance Achieved	6/21/2010

Name of the Public Water Supply (Alphabetical Listing)	Minimum Population Served	County	PWSID	PWS Type	Violation Number	Analyte	Compliance End Date	Violation	Violation Type	Enforcement Action	Enforcement Action Date
VERN LAURES AUTO CENTER INC	51	CHICKASAW	IA1970207	TNC	201100321	Coliform, Total (TCR)	31-Dec-10	MCL (TCR), Monthly	MCL	Compliance Achieved	1/18/2011
VERN LAURES AUTO CENTER INC	51	CHICKASAW	IA1970207	TNC	201107089	Coliform, Total (TCR)	30-Nov-10	MCL (TCR), Monthly	MCL	Compliance Achieved	1/18/2011
VERN LAURES AUTO CENTER INC	51	CHICKASAW	IA1970207	TNC	201107148	Coliform, Total (TCR)	30-Nov-10	Monitoring (TCR), Repeat Major	MON	Compliance Achieved	12/21/2010
VERN LAURES AUTO CENTER INC	51	CHICKASAW	IA1970207	TNC	201107239	Coliform, Total (TCR)	29-Nov-10	Monitoring (GWR), Source Major	MON	Compliance Achieved	12/21/2010
VERNON WATER CO	255	DUBUQUE	IA3126315	CWS	201001036	Failure to meet Certified Operator Requirement	05-Mar-10	Certified Operator Requirement	STA	Compliance Achieved	6/24/2010
VERNON WATER CO	255	DUBUQUE	IA3126315	CWS	201001438	Chlorine	31-Mar-10	Record Keeping	RPT	Compliance Achieved	7/8/2010
VERNON WATER CO	255	DUBUQUE	IA3126315	CWS	201006212	Chlorine Residual	30-Jun-10	Record Keeping	RPT	Compliance Achieved	11/22/2010
VICTORY LIFE CHRISTIAN CENTER	51	FREMONT	IA3661801	TNC	201006502	Coliform, Total (TCR)	31-Aug-10	MCL (TCR), Monthly	MCL	Compliance Achieved	12/17/2010
VICTORY LIFE CHRISTIAN CENTER	51	FREMONT	IA3661801	TNC	201107053	Nitrate (as N)	31-Oct-10	Monitoring (Chem-Rad), Routine Major	MON	Compliance Achieved	12/17/2010
VILLAGE CREEK BIBLE CAMP	166	ALLAMAKEE	IA0345481	TNC	201001071	Coliform, Total (TCR)	31-Jan-10	Monitoring (TCR), Routine Major	MON	Compliance Achieved	8/31/2010
VILLAGE CREEK BIBLE CAMP	166	ALLAMAKEE	IA0345481	TNC	201006332	Coliform, Total (TCR)	31-Jul-10	Monitoring (TCR), Routine Major	MON	Compliance Achieved	8/31/2010
VILLAGER RESTAURANT	313	POTTAWATTAMIE	IA7872706	TNC	201001587	Coliform, Total (TCR)	30-Apr-10	Monitoring (TCR), Routine Major	MON	Compliance Achieved	5/27/2010
WALDENBURG COMMUNITY WATER SYSTEM	90	IOWA	IA4802301	CWS	201001861	Coliform, Total (TCR)	30-Jun-10	MCL (TCR), Monthly	MCL	Compliance Achieved	1/24/2011
WALDENBURG COMMUNITY WATER SYSTEM	90	IOWA	IA4802301	CWS	201002219	Coliform, Total (TCR)	31-Jul-10	MCL (TCR), Monthly	MCL	Compliance Achieved	1/24/2011
WALDENBURG COMMUNITY WATER SYSTEM	90	IOWA	IA4802301	CWS	201106882	Gross Alpha, excluding Rn & U	31-Dec-10	MCL (Chem-Rad), Average	MCL	Compliance Achieved	2/28/2011
WALKER WATER WORKS	754	LINN	IA5792059	CWS	201001440	Chlorine	31-Mar-10	Record Keeping	RPT	Compliance Achieved	4/26/2010

Name of the Public Water Supply (Alphabetical Listing)	Minimum Population Served	County	PWSID	PWS Type	Violation Number	Analyte	Compliance End Date	Violation	Violation Type	Enforcement Action	Enforcement Action Date
WALNUT ACRES CAMPGROUND	50	JONES	IA5343203	TNC	201001762	Coliform, Total (TCR)	31-May-10	Monitoring (TCR), Routine Major	MON	Compliance Achieved	6/23/2010
WALNUT ACRES CAMPGROUND	50	JONES	IA5343203	TNC	201006449	Coliform, Total (TCR)	31-Aug-10	MCL (TCR), Monthly	MCL	Compliance Achieved	5/17/2011
WAPELLO MUNICIPAL WATER WORKS	2124	LOUISA	IA5879063	CWS	201006229	Fecal Coliform	31-Aug-10	MCL (TCR), Acute	MCL	Compliance Achieved	9/29/2010
WAPELLO MUNICIPAL WATER WORKS	2124	LOUISA	IA5879063	CWS	201006230	Coliform, Total (TCR)	31-Aug-10	MCL (TCR), Monthly	MCL	Compliance Achieved	9/29/2010
WAPSIPINICON COUNTRY CLUB	85	JONES	IA5307200	TNC	201000858	Coliform, Total (TCR)	31-Jan-10	MCL (TCR), Monthly	MCL	Compliance Achieved	9/28/2010
WAPSIPINICON COUNTRY CLUB	85	JONES	IA5307200	TNC	201001054	Failure to meet Certified Operator Requirement	08-Feb-10	Certified Operator Requirement	STA	Compliance Achieved	5/7/2010
WAPSIPINICON COUNTRY CLUB	85	JONES	IA5307200	TNC	201001294	Coliform, Total (TCR)	31-Mar-10	MCL (TCR), Monthly	MCL	Compliance Achieved	9/28/2010
WARREN WATER DISTRICT	13694	WARREN	IA9133701	CWS	201001429	Chlorine	30-Apr-10	Record Keeping	RPT	Compliance Achieved	5/5/2010
WASHINGTON TWSP. ELEMENTARY SCHOOL	160	WASHINGTON	IA9233522	NTNC	201002114	Coliform, Total (TCR)	30-Jun-10	Monitoring (TCR), Routine Major	MON	Compliance Achieved	8/4/2010
WASHINGTON TWSP. ELEMENTARY SCHOOL	160	WASHINGTON	IA9233522	NTNC	201006391	Coliform, Total (TCR)	31-Jul-10	Monitoring (TCR), Routine Major	MON	Compliance Achieved	8/4/2010
WASHINGTON WATER DEPARTMENT	7047	WASHINGTON	IA9271068	CWS	201100200	Total Haloacetic Acids (HAA5)	31-Aug-10	Monitoring (DBP), Major	MON	BCA Signed	10/20/2010
WASHINGTON WATER DEPARTMENT	7047	WASHINGTON	IA9271068	CWS	201100201	Total Trihalomethanes (TTHM)	31-Aug-10	Monitoring (Chem-Rad), Routine Major	MON	BCA Signed	10/20/2010
WAUBONSIE ST PK (BRIDLE TRAIL)	66	FREMONT	IA3600918	TNC	201100043	Coliform, Total (TCR)	31-Oct-10	MCL (TCR), Monthly	MCL	Compliance Achieved	5/4/2011
WAUBONSIE ST PK (BRIDLE TRAIL)	66	FREMONT	IA3600918	TNC	201107353	Nitrate (as N)	31-Dec-10	Monitoring (Chem-Rad), Routine Major	MON	Compliance Achieved	5/4/2011
WAVERLY MOBILE HOME PARK	150	BREMER	IA0900601	CWS	201001909	Nitrate (as N)	31-Jul-10	MCL (Chem-Rad), Single Sample	MCL	Compliance Achieved	9/1/2010
WAVERLY MOBILE HOME PARK	150	BREMER	IA0900601	CWS	201002271	Coliform, Total (TCR)	31-Aug-10	MCL (TCR), Monthly	MCL	Compliance Achieved	9/1/2010

Name of the Public Water Supply (Alphabetical Listing)	Minimum Population Served	County	PWSID	PWS Type	Violation Number	Analyte	Compliance End Date	Violation	Violation Type	Enforcement Action	Enforcement Action Date
WAVERLY MOBILE HOME PARK	150	BREMER	IA0900601	CWS	201006531	Failure to Issue Consumer Confidence Report	31-Jul-10	Consumer Confidence Report (CCR)	RPT	Compliance Achieved	9/1/2010
WAVERLY WATER DEPARTMENT	8968	BREMER	IA0990085	CWS	201100300	Copper	30-Sep-10	Routine/Repeat Tap Sampling (Pb/Cu)	MON	NOV Issued	10/18/2010
WAVERLY WATER DEPARTMENT	8968	BREMER	IA0990085	CWS	201100301	Lead	30-Sep-10	Routine/Repeat Tap Sampling (Pb/Cu)	MON	NOV Issued	10/18/2010
WAYNE ZION LUTHERAN CHURCH	52	JONES	IA5343801	TNC	201001137	Coliform, Total (TCR)	31-Jan-10	Monitoring (TCR), Routine Major	MON	Compliance Achieved	2/4/2010
WAYNE ZION LUTHERAN CHURCH	52	JONES	IA5343801	TNC	201100243	Coliform, Total (TCR)	30-Sep-10	Monitoring (TCR), Routine Major	MON	Compliance Achieved	10/26/2010
WAYNE ZION LUTHERAN CHURCH	52	JONES	IA5343801	TNC	201107234	Coliform, Total (TCR)	30-Nov-10	Monitoring (TCR), Routine Major	MON	Compliance Achieved	1/3/2011
WAYNE ZION LUTHERAN CHURCH	52	JONES	IA5343801	TNC	201107413	Coliform, Total (TCR)	31-Dec-10	Monitoring (TCR), Routine Major	MON	Compliance Achieved	1/3/2011
WEBSTER MUNICIPAL WATER WORKS	110	KEOKUK	IA5491093	CWS	201001442	Radium, Combined (226, 228)	31-Mar-10	Monitoring (Chem-Rad), Routine Major	MON	Compliance Achieved	4/22/2010
WELLMAN MUNICIPAL WATERWORKS	1408	WASHINGTON	IA9276096	CWS	201001875	Nitrite (as N)	30-Jun-10	MCL (Chem-Rad), Single Sample	MCL	BCA Signed	5/29/2008
WELLMAN MUNICIPAL WATERWORKS	1408	WASHINGTON	IA9276096	CWS	201002255	Nitrite (as N)	31-Jul-10	MCL (Chem-Rad), Single Sample	MCL	BCA Signed	5/29/2008
WELLMAN MUNICIPAL WATERWORKS	1408	WASHINGTON	IA9276096	CWS	201107120	Nitrite (as N)	30-Nov-10	MCL (Chem-Rad), Single Sample	MCL	BCA Signed	5/29/2008
WEST LAKE LOUNGE LLC	35	SCOTT	IA8222738	TNC	201001823	Fecal Coliform	30-Jun-10	MCL (TCR), Acute	MCL	Compliance Achieved	9/27/2010
WEST LAKE LOUNGE LLC	35	SCOTT	IA8222738	TNC	201001824	Coliform, Total (TCR)	30-Jun-10	MCL (TCR), Monthly	MCL	Compliance Achieved	9/27/2010
WEST LAKE LOUNGE LLC	35	SCOTT	IA8222738	TNC	201006276	Coliform, Total (TCR)	31-Jul-10	Monitoring (TCR), Routine Major	MON	Compliance Achieved	9/27/2010
WEST LAKE LOUNGE LLC	35	SCOTT	IA8222738	TNC	201006417	Coliform, Total (TCR)	01-Jul-10	Monitoring (GWR), Source Major	MON	Compliance Achieved	9/27/2010
WEST LIBERTY FOODS	1078	MUSCATINE	IA7073834	NTNC	201107011	Coliform, Total (TCR)	31-Oct-10	Monitoring (TCR), Routine Major	MON	Compliance Achieved	11/5/2010

Name of the Public Water Supply (Alphabetical Listing)	Minimum Population Served	County	PWSID	PWS Type	Violation Number	Analyte	Compliance End Date	Violation	Violation Type	Enforcement Action	Enforcement Action Date
WESTFAIR	301	POTTAWATTAMIE	IA7820401	TNC	201001598	Coliform, Total (TCR)	30-Apr-10	Monitoring (TCR), Routine Major	MON	Compliance Achieved	5/26/2010
WESTFAIR	301	POTTAWATTAMIE	IA7820401	TNC	201001599	Coliform, Total (TCR)	30-Apr-10	Monitoring (TCR), Routine Major	MON	Compliance Achieved	5/26/2010
WESTFAIR	301	POTTAWATTAMIE	IA7820401	TNC	201002127	Nitrate (as N)	30-Jun-10	Monitoring (Chem-Rad), Routine Major	MON	Compliance Achieved	9/27/2010
WESTFAIR	301	POTTAWATTAMIE	IA7820401	TNC	201006393	Coliform, Total (TCR)	31-Jul-10	Monitoring (TCR), Routine Major	MON	Compliance Achieved	5/26/2010
WESTFAIR	301	POTTAWATTAMIE	IA7820401	TNC	201006394	Coliform, Total (TCR)	31-Jul-10	Monitoring (TCR), Routine Major	MON	Compliance Achieved	4/28/2011
WESTFAIR	301	POTTAWATTAMIE	IA7820401	TNC	201107031	Coliform, Total (TCR)	31-Oct-10	Monitoring (TCR), Routine Major	MON	Compliance Achieved	4/28/2011
WESTFIELD WATER SUPPLY	195	PLYMOUTH	IA7589008	CWS	201107226	Coliform, Total (TCR)	30-Nov-10	Monitoring (TCR), Routine Major	MON	Compliance Achieved	12/6/2010
WESTFIELD WATER SUPPLY	195	PLYMOUTH	IA7589008	CWS	201107252	Chlorine	31-Dec-10	Monitoring (DBP), Major	MON	Compliance Achieved	3/31/2011
WESTGATE WATER SUPPLY	234	FAYETTE	IA3379009	CWS	201107351	Coliform, Total (TCR)	31-Dec-10	Monitoring (TCR), Routine Major	MON	Compliance Achieved	4/12/2011
WESTGATE WATER SUPPLY	234	FAYETTE	IA3379009	CWS	201107432	Chlorine	31-Dec-10	Monitoring (DBP), Major	MON	NOV Issued	1/19/2011
WHEATLAND CITY WATER SUPPLY	764	CLINTON	IA2394017	CWS	201001615	Total Trihalomethanes (TTHM)	31-Mar-10	MCL (Chem-Rad), Average	MCL	Compliance Achieved	12/31/2010
WHEATLAND CITY WATER SUPPLY	764	CLINTON	IA2394017	CWS	201001627	Total Trihalomethanes (TTHM)	30-Jun-10	MCL (Chem-Rad), Average	MCL	Compliance Achieved	12/31/2010
WHEATLAND CITY WATER SUPPLY	764	CLINTON	IA2394017	CWS	201107339	Nitrite (as N)	31-Dec-10	Monitoring (Chem-Rad), Routine Major	MON	Compliance Achieved	3/23/2011
WHISKEY CREEK FEEDLOT INC	28	WOODBURY	IA9778107	NTNC	201107258	Coliform, Total (TCR)	31-Dec-10	MCL (TCR), Monthly	MCL	Compliance Achieved	1/26/2011
WHITTEMORE COUNTRY CLUB	55	KOSSUTH	IA5595815	TNC	201002093	Coliform, Total (TCR)	30-Jun-10	Monitoring (TCR), Routine Major	MON	Compliance Achieved	7/21/2010
WHITTEMORE COUNTRY CLUB	55	KOSSUTH	IA5595815	TNC	201100172	Nitrite (as N)	30-Sep-10	Monitoring (Chem-Rad), Routine Major	MON	NOV Issued	10/19/2010

Name of the Public Water Supply (Alphabetical Listing)	Minimum Population Served	County	PWSID	PWS Type	Violation Number	Analyte	Compliance End Date	Violation	Violation Type	Enforcement Action	Enforcement Action Date
WIELE MOTOR	31	LOUISA	IA5815201	TNC	201002150	Coliform, Total (TCR)	30-Jun-10	Monitoring (TCR), Routine Major	MON	Compliance Achieved	7/12/2010
WILD FLOWER RIDGE SUBDIVISION	50	DUBUQUE	IA3126310	CWS	201006533	Failure to Issue Consumer Confidence Report	31-Jul-10	Consumer Confidence Report (CCR)	RPT	Compliance Achieved	9/3/2010
WILDWOOD WATER CORPORATION	185	DALLAS	IA2570301	CWS	201001330	Lead	30-Jun-10	AL (Pb/Cu), 90th Percentile	MCL	BCA Signed	11/24/2010
WILDWOOD WATER CORPORATION	185	DALLAS	IA2570301	CWS	201107727	Lead	31-Dec-10	AL (Pb/Cu), 90th Percentile	MCL	BCA Signed	4/4/2011
WILKINSON PIONEER PARK	27	CERRO GORDO	IA1769927	TNC	201001612	Coliform, Total (TCR)	30-Jun-10	MCL (TCR), Monthly	MCL	Compliance Achieved	8/23/2010
WILSON ISLAND STATE REC AREA	60	HARRISON	IA4344991	TNC	201107211	Coliform, Total (TCR)	30-Nov-10	Monitoring (TCR), Routine Major	MON	Compliance Achieved	12/6/2010
WINDING BROOK MOBILE HOME PARK	150	CLINTON	IA2300607	CWS	201001650	Nitrate (as N)	31-May-10	MCL (Chem-Rad), Single Sample	MCL	Compliance Achieved	1/18/2011
WINDING BROOK MOBILE HOME PARK	150	CLINTON	IA2300607	CWS	201006539	Failure to Issue Consumer Confidence Report	01-Jul-10	Consumer Confidence Report (CCR)	RPT	Compliance Achieved	9/3/2010
WINDING BROOK MOBILE HOME PARK	150	CLINTON	IA2300607	CWS	201006874	Nitrate (as N)	19-Oct-10	Compliance Schedule	V/E	BCA Signed	9/29/2010
WINDING BROOK MOBILE HOME PARK	150	CLINTON	IA2300607	CWS	201100128	Total Trihalomethanes (TTHM)	31-Aug-10	Monitoring (Chem-Rad), Routine Major	MON	NOV Issued	10/18/2010
WINDING BROOK MOBILE HOME PARK	150	CLINTON	IA2300607	CWS	201100129	Total Haloacetic Acids (HAA5)	31-Aug-10	Monitoring (DBP), Major	MON	NOV Issued	10/18/2010
WINFIELD MUNI WATER DEPT	1150	HENRY	IA4493028	CWS	201006538	Failure to Issue Consumer Confidence Report	01-Jul-10	Consumer Confidence Report (CCR)	RPT	Compliance Achieved	9/15/2010
WINNESHIEK WILDBERRY WINERY	122	WINNESHIEK	IA9630210	TNC	201001245	Coliform, Total (TCR)	28-Feb-10	Monitoring (TCR), Routine Major	MON	Compliance Achieved	3/22/2010
WINNESHIEK WILDBERRY WINERY	122	WINNESHIEK	IA9630210	TNC	201001722	Coliform, Total (TCR)	31-May-10	Monitoring (TCR), Routine Major	MON	Compliance Achieved	6/7/2010
WINNESHIEK WILDBERRY WINERY	122	WINNESHIEK	IA9630210	TNC	201100248	Coliform, Total (TCR)	30-Sep-10	Monitoring (TCR), Routine Major	MON	Compliance Achieved	11/30/2010
WIOTA WATER WORKS	149	CASS	IA1570032	CWS	201006441	Iowa Administrative Code	30-Jun-10	Monitoring (MOR)	MON	Compliance Achieved	8/9/2010

Name of the Public Water Supply (Alphabetical Listing)	Minimum Population Served	County	PWSID	PWS Type	Violation Number	Analyte	Compliance End Date	Violation	Violation Type	Enforcement Action	Enforcement Action Date
WOODLAND ACRES	92	WEBSTER	IA9433600	CWS	201100045	Coliform, Total (TCR)	31-Oct-10	MCL (TCR), Monthly	MCL	Compliance Achieved	12/13/2010
WOODLAND ACRES	92	WEBSTER	IA9433600	CWS	201107177	Coliform, Total (TCR)	30-Nov-10	Monitoring (TCR), Repeat Major	MON	Compliance Achieved	12/13/2010
WOODLAND ACRES	92	WEBSTER	IA9433600	CWS	201107246	Coliform, Total (TCR)	25-Nov-10	Monitoring (GWR), Source Major	MON	Compliance Achieved	12/13/2010
WOODLAND HEIGHTS HOMEOWNERS ASSOC.	43	JOHNSON	IA5225309	CWS	201006508	Coliform, Total (TCR)	31-Aug-10	MCL (TCR), Monthly	MCL	Compliance Achieved	1/25/2011
WOODLAND HEIGHTS HOMEOWNERS ASSOC.	43	JOHNSON	IA5225309	CWS	201006868	Copper	30-Sep-10	AL (Pb/Cu), 90th Percentile	MCL	BCA Signed	10/1/2010
WOODLAND WAPELLO MOBILE HOME PARK	126	LOUISA	IA5879601	CWS	201006545	Failure to Issue Consumer Confidence Report	01-Jul-10	Consumer Confidence Report (CCR)	RPT	Compliance Achieved	9/2/2010
WOODLAND WAPELLO MOBILE HOME PARK	126	LOUISA	IA5879601	CWS	201106934	Coliform, Total (TCR)	31-Oct-10	Monitoring (TCR), Repeat Major	MON	NOV Issued	4/25/2011
WOODLAND WAPELLO MOBILE HOME PARK	126	LOUISA	IA5879601	CWS	201107062	Coliform, Total (TCR)	28-Oct-10	Monitoring (GWR), Source Major	MON	NOV Issued	4/25/2011
WORD OF FAITH DOMINION CHURCH	61	WINNEBAGO	IA9545801	TNC	201002035	Coliform, Total (TCR)	30-Jun-10	Monitoring (TCR), Repeat Major	MON	Compliance Achieved	6/29/2010
WORD OF FAITH DOMINION CHURCH	61	WINNEBAGO	IA9545801	TNC	201002163	Coliform, Total (TCR)	26-Jun-10	Monitoring (GWR), Source Major	MON	Compliance Achieved	6/29/2010
WORD OF FAITH DOMINION CHURCH	61	WINNEBAGO	IA9545801	TNC	201002247	Fecal Coliform	30-Sep-10	MCL (TCR), Acute	MCL	Compliance Achieved	9/9/2010
WORD OF FAITH DOMINION CHURCH	61	WINNEBAGO	IA9545801	TNC	201002248	Coliform, Total (TCR)	30-Sep-10	MCL (TCR), Monthly	MCL	Compliance Achieved	9/9/2010
WORD OF FAITH DOMINION CHURCH	61	WINNEBAGO	IA9545801	TNC	201006487	Coliform, Total (TCR)	31-Aug-10	MCL (TCR), Monthly	MCL	Compliance Achieved	9/9/2010
WYOMING WATER SYSTEM	515	JONES	IA5396039	CWS	201100168	Total Haloacetic Acids (HAA5)	31-Aug-10	Monitoring (DBP), Major	MON	NOV Issued	10/18/2010
WYOMING WATER SYSTEM	515	JONES	IA5396039	CWS	201100169	Total Trihalomethanes (TTHM)	31-Aug-10	Monitoring (Chem-Rad), Routine Major	MON	NOV Issued	10/18/2010
XENIA RWD (WOODWARD)	3510	DALLAS	IA2576705	CWS	201001470	Coliform, Total (TCR)	31-May-10	MCL (TCR), Monthly	MCL	Compliance Achieved	12/14/2010

Name of the Public Water Supply (Alphabetical Listing)	Minimum Population Served	County	PWSID	PWS Type	Violation Number	Analyte	Compliance End Date	Violation	Violation Type	Enforcement Action	Enforcement Action Date
XENIA RWD (WOODWARD)	3510	DALLAS	IA2576705	CWS	201006501	Arsenic	30-Jun-10	MCL (Chem-Rad), Single Sample	MCL	NOV Issued	8/30/2010
YMCA CAMP POKAMOKE	1500	POTTAWATTAMIE	IA7822801	TNC	201001764	Coliform, Total (TCR)	31-May-10	Monitoring (TCR), Routine Major	MON	Compliance Achieved	6/22/2010
YMCA CAMP POKAMOKE	1500	POTTAWATTAMIE	IA7822801	TNC	201006326	Coliform, Total (TCR)	31-Jul-10	Monitoring (TCR), Routine Major	MON	Compliance Achieved	4/13/2011
YMCA CAMP POKAMOKE	1500	POTTAWATTAMIE	IA7822801	TNC	201006753	Coliform, Total (TCR)	31-Aug-10	Monitoring (TCR), Routine Major	MON	Compliance Achieved	4/13/2011
YMCA CAMP POKAMOKE	1500	POTTAWATTAMIE	IA7822801	TNC	201100218	Coliform, Total (TCR)	30-Sep-10	Monitoring (TCR), Routine Major	MON	Compliance Achieved	4/13/2011